Technical Operation Manual

Serial Interface Unit

ISO Plug-in Manifold Valve

Rev 1.001 29.Jun.2001

SI Unit Model No. : EX230-SPR1

Contents

1. Summary.....	3
2. Structure.....	3
● 2 – 1 System structure.....	3
● 2 – 2 SI unit structure.....	3
3. Specifications.....	5
● 3 – 1 General specifications.....	5
● 3 – 2 Communication specifications.....	5
● 3 – 3 SI unit specifications.....	6
4. Parts description and function.....	7
● 4 – 1 LED display.....	8
● 4 – 2 Switch (SW) function.....	8
● 4 – 3 Connector function.....	8
5. How to set up SW.....	9
● 5 – 1 Address setting.....	9
● 5 – 2 Output reset setting.....	9
6. Connection method.....	10
● 6 – 1 Connection of Communication cable.....	10
● 6 – 2 Connection of Power supply cable.....	11
7. Actuation and LED display.....	12
● 7 – 1 Actuation of SI unit.....	12
● 7 – 2 Actuation of output excessive current protection.....	13
8. Maintenance.....	14
● 8 – 1 Procedure to exchange SI unit.....	14
● 8 – 2 Procedure to exchange fuse.....	14
9. Map for system control.....	15
● 9 – 1 I/O assignment.....	15
● 9 – 2 Bit mapping.....	15
● 9 – 3 GSD file.....	16

1. Summary

EX230-SPR1 is Open Field Bus conforming to EN50170. This is SI (Serial Interface) unit for ISO plug-in manifold and can be connected to PROFIBUS-DP. Its specifications and handling method are shown below.

2. Structure

●2-1 System structure

SI unit, together with ISO plug-in manifold, is connected to PROFIBUS-DP protocol system, such as a manufacturing line, and is used as a slave device in the system.

Figure 2.1 shows an example of proper SI unit connection.

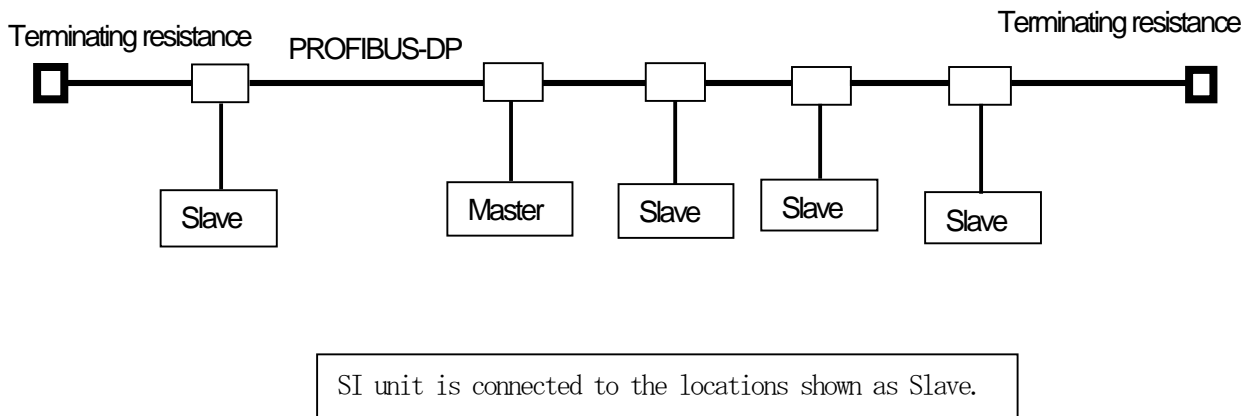

Figure 2.1 System configuration

●2-2 SI Unit structure

SI Unit consists of micro computer, communication control ASIC, output driver circuit, LED, SW and DC-DC converter.

Figure 2.2 shows a block diagram of SI unit interior.

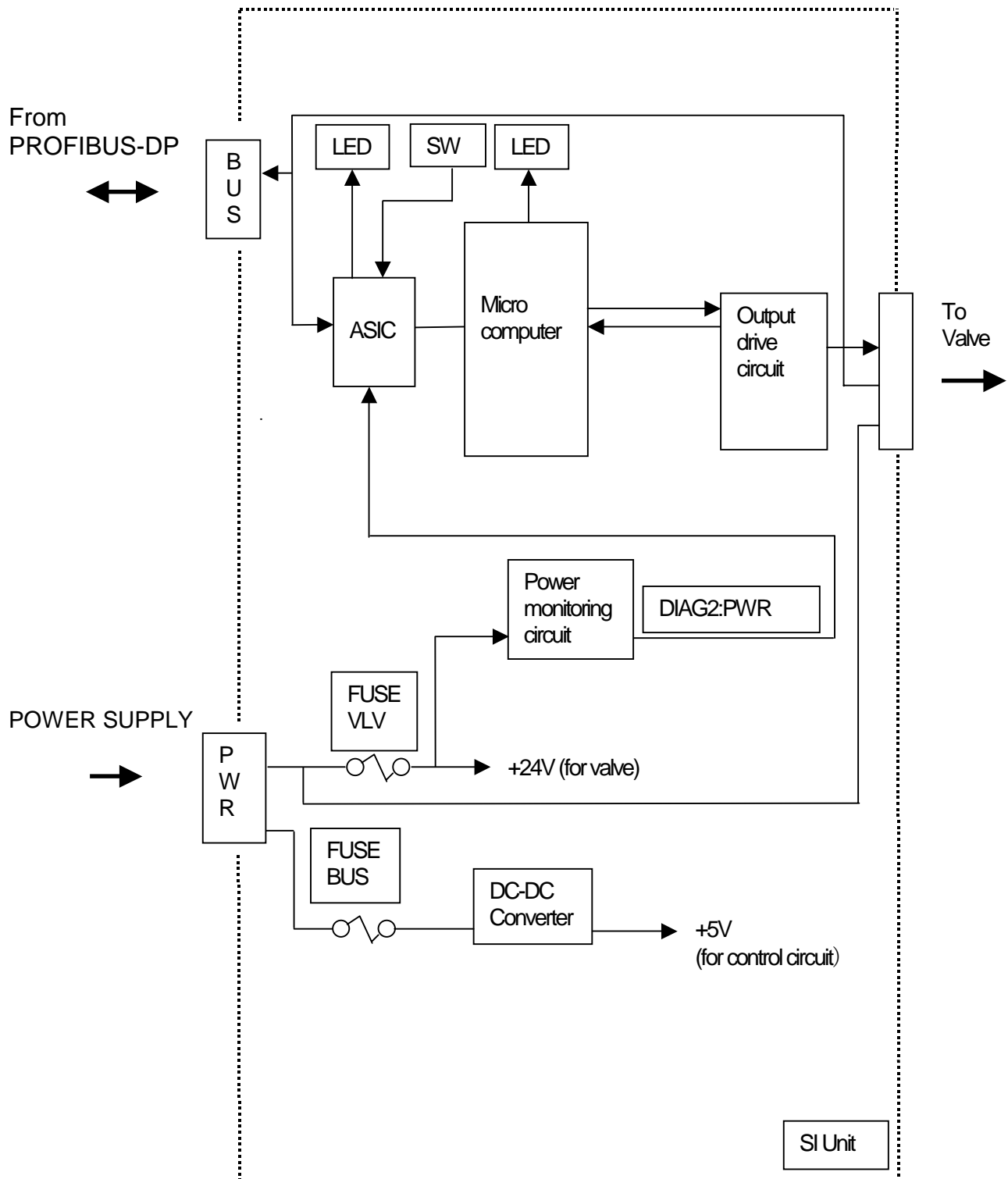

Figure 2.2 Block diagram of SI Unit

3. Specifications

● 3 – 1 General specifications

Item	Specifications
Protective class	IP65 (NEMA 4)
Operating ambient temperature	+5 ~ +45°C
Operating ambient moisture	35~85%RH (Non condensing)
Vibration resistance	5G (10~55Hz Amplitude 0.50mm)
Shock resistance	Peak acceleration 10G
Noise resistance	1000Vp-p Pulse width 100ns~1 μ S leading edge 1ns pulse
Voltage resistance	Between external terminal package and case, AC1000V,50/60Hz 1 minute
Isolation resistance	Between external terminal package and case, 10MΩ
Environment	No corrosive gas. No dust.

● 3 – 2 Communication specifications

Item	Specification	
Applicable system	PROFIBUS-DP	
address	1~126 (SW mode), 1~99 (HW mode)	
Communication speed	9.6k~12M bit / sec	
Max. cable length	Communication speed (Kbit / s)	Distance/Segment (m)
	9.6	1,200
	19.2	1,200
	93.75	1,200
	187.5	1,000
	500	400
	1,500	200
	3,000~12,000	100

●3-3 SI Unit specifications

Item	Specifications
Output point	16 points
Output type	PNP transistor, open collector type, sourcing (with the function of excessive current protection)
Connection load	Solenoid valve with DC24V,2.8W or less lamp surge voltage protection circuit
Input point	16 points
Input contents	0~15 : Excessive current detecting status
Input point of DIAG	1 point
DIAG contents	Responds with the state of power for solenoids: Byte7, bit 2 of diagnostic telegram (SLAV_DIAG)
Power supply voltage, Consumption current	DC20~25V (For control circuit), 0.5A (Max)
	DC20~26.4V (For solenoid valve), 2.0A (Max)
Weight	600g or less
Dimensions (D×W×H) [mm]	(71)×(167)×(57)

4. Parts description and function

Figure 4.1 shows SI Unit appearance.

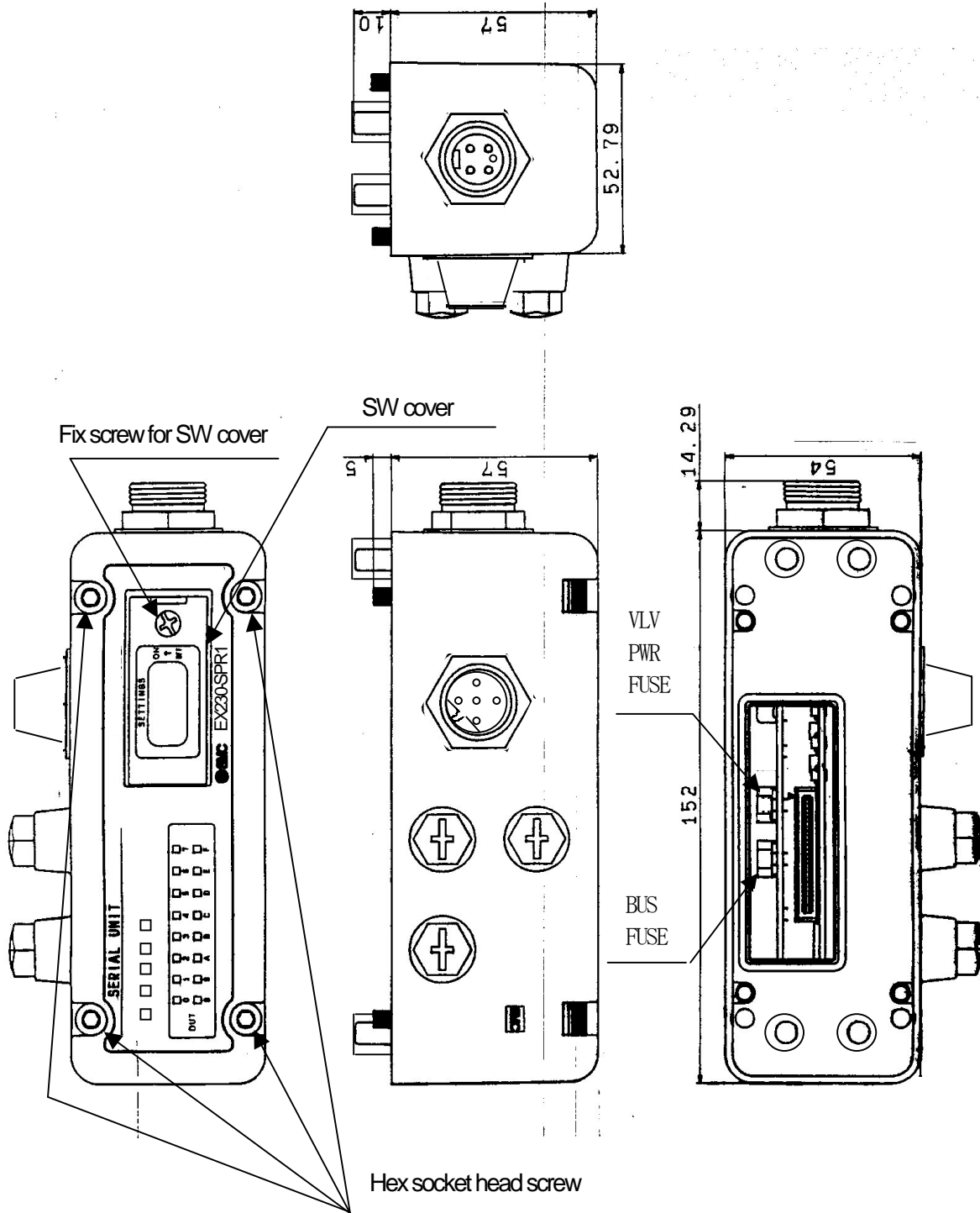

Figure 4.1 SI Unit appearance

● 4-1 LED display

Name	Function
BF	Display the status of communication to PROFIBUS-DP
DIA	Display the results of self-diagnosis
AUTO RESET	Display the status of auto reset DIP SW. (SW3 BIT4)
RUN	Display status of the SI unit, BUS power source.
AUX PWR	Display status of the solenoid valve, power source (AUX PWR).
OUT 0 ~ 15	Display the output status.

(Refer to item 7 for the details)

● 4-2 SW functions

(1) Rotary SW

Rotary SW sets address by means of SW(x10) and SW(x1) in hardware mode.

(2) DIP SW

DIP SW sets address setting mode and output reset mode.

Figure 4.2.1 SW3 function

Bit No.	Function
1	Selects address setting mode. (SW mode : Set from network, HW mode : Set with SW1 and 2.)
2	_____
3	_____
4	When solenoid valve output shorts, this bit selects either HOLD indefinitely while output remains OFF (power cycle to reset) or automatic output reset when short state has been corrected or removed.

● 4-3 Connector function

No.	Name	Function
1	BUS IN	Connect to PROFIBUS cable.
2	PWR IN	Connect to source cable.

5. How to Set up SW

Indication part of SI unit is equipped with 2 rotary switches (SW1:x10,SW2:x1) and one DIP switch (SW3:4bit) .

Before setting each switch, loosen cover fixing screws to open the cover.

● 5 – 1 Address setting

(1) Software setting mode

SI unit is in the software address setting mode when bit 1 of SW3 is OFF state. Address should be set through network by using hand held unit and programming tools.

<Notes>

1. Address setting range : 1~126 (decimal)
2. Once address is set, it is hold until it is reset made even if power is turned OFF.

(2) Hardware setting mode

SI unit is in the hardware address setting mode when bit 1 of SW3 is ON state. Set the number of tens with SW 1 and the number of units with SW2.

<Note>

1. Address setting range : 1~99 (decimal)

● 5 – 2 Output reset setting

Table 5.2.1 shows the setting method of SW3.

Table 5.2.1 Setting method of SW3

SW3 No.		1	2	3	4
HW/SW	SW	0			
	HW	1			
RESERVE	OFF		0		
RESERVE	OFF			0	
AUTORESET	OFF				0
	ON				1

Assignment of address setting mode (ON: Hardware setting mode)

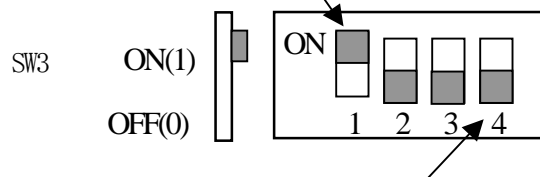

Setting to reset from excess current protective operation

(OFF: Output is hold OFF until power is turned OFF when excess output current is detected.)

6. Connection method

● 6 – 1 Connection of Communication cable

- All devices of PROFIBUS-DP are connected according to BUS configuration.
- Active BUS terminating resistance is connected to the starting and ending position of each segment.
- Maximum 32 devices can be connected per one segment.
- When more than 32 devices are connected, use repeater (line amplifier) to connect each BUS segment.
- The maximum length of cable/segment varies according to the communication speed. Please refer to Table 6.1.1.
- SI unit can be connected to the positions shown as slave in Figure 6.1.1.
- PROFIBUS-DP cable should be connected to BUS I Nconnector for SI unit.

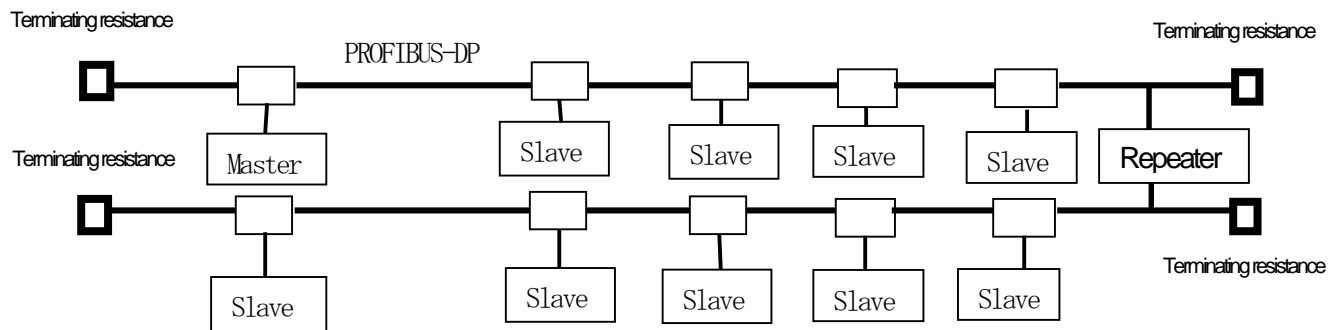

Figure 6.1.1 Connection configuration

Table 6.1.1 Maximum cable length

Baudot rate (Kbit/S)	9.6	19.2	93.75	187.5	500	1,500	12,000
Distance/segment(m)	1,200	1,200	1,200	1,000	400	200	100

Table 6.1.2 Cable specification

No	Item	Type A cable
1	Impedance	135~165 Ω / 3~20 MHz
2	Capacity	< 30pF/m
3	Loop resistance	< 110 Ω / Km
4	Wire gauge	> 0.64mm
5	Conductor area	> 0.34mm ²

Notes

- 1) Customer should prepare T type branch connector for SI unit connection.
<Reference> Model No. of T type branch connector : VB2 FSW FKW FSW 45 (made by interlinkBT)
- 2) Type A cable should be used as communication cable.
- 3) Be sure to connect PROFIBUS-DP terminating resistance to both ends of the segment.

Table 6.1.3 BUS connector specification

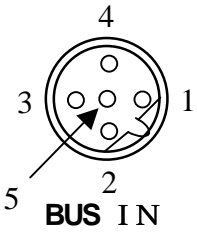
Description	Function
 <p style="text-align: center;">BUS IN</p>	<p>BUS connects PROFIBUS-DP cable. Model name : 5-pin connector (Micro style) Female Model No. : Equivalent to FKW4.5(made by TURCK) Signals : 1. 5Volts 2. BusA 3. Ground 4. BusB 5. Shield</p>

● 6 – 2 Connection of power supply cable

- Connect power supply cable to PWR I N connector of SI unit.

Table 6.2.1 PWR connector specification

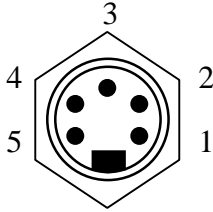
Description	Function
 <p style="text-align: center;">PWR IN</p>	<p>PWR connects power cable. Model name : 5-pin connector (Mini style) Male Model No. : Equivalent to 84854-9101(made by MOLEX) Signals : 1. Aux. GND 2. Bus GND 3. Earth GND 4. Bus +24 5. Aux. +24</p>

7. Actuation and LED display

● 7-1 Actuation of SI unit

SI unit actuate as follows normally.

Table 7.1 shows LED display specification.

- (1) When BUS power is turned ON, SI unit RUN LED illuminates.
(If AUTO RESET mode is set, AUTO RESET LED illuminates.)
- (2) SI unit makes self-diagnosis and checks PROFIBUS-DP to establish communication with master.
(When abnormality is detected by self-diagnosis or by BUS check, DIA LED and BF LED will illuminate red.)
- (3) When power for solenoid valve is turned ON, AUX PWR LED of SI unit illuminates.
*** With above complete, SI unit is functioning properly.**
- (4) Hereafter, turn ON/OFF according to command from PROFIBUS-DP master.
Moreover, respond status to the master if output short is detected.
Also, respond the diagnostic telegram(SLAV_DIAG) to the master if solenoid power drop is detected.

Table 7.1 Specification of LED indication

Name	Description	
BF	Red steadily	PROFIBUS-DP communication error
	OFF	Normal PROFIBUS-DP communication
DIA	Red steadily	Abnormal self-diagnosis detected
	OFF	Normal self-diagnosis
AUTO RESET	Green steadily	Excessive current protection AUTO RESET mode
	OFF	Not excessive current protection AUTO RESET mode
RUN	Green steadily	Power for control circuit is ON
	OFF	Power for control circuit is OFF
AUX PWR	Green steadily	Power for solenoid valve is turned ON with 20V or over
	Red steadily	Power for solenoid valve is turned ON with 18V~20V
	OFF	Power for solenoid valve is turned OFF or less than 18V
OUT 0 ~ 15	Orange steadily	Output toward solenoid valve is turned ON
	Orange flashing	Output toward solenoid valve is shorted
	OFF	Output toward solenoid valve is turned OFF

● 7-2 Actuation of output excessive current protection

(1) When AUTO RESET OFF

SI unit executes the following procedure in response to output command from PROFIBUS-DP master.

- ① Turn ON solenoid valve according to command. (OUTPUT LED steady)
- ② Turn OFF solenoid valve when output excessive current occurs. (OUTPUT LED flashing)

Output OFF status holds until power supply for BUS is turned OFF.)

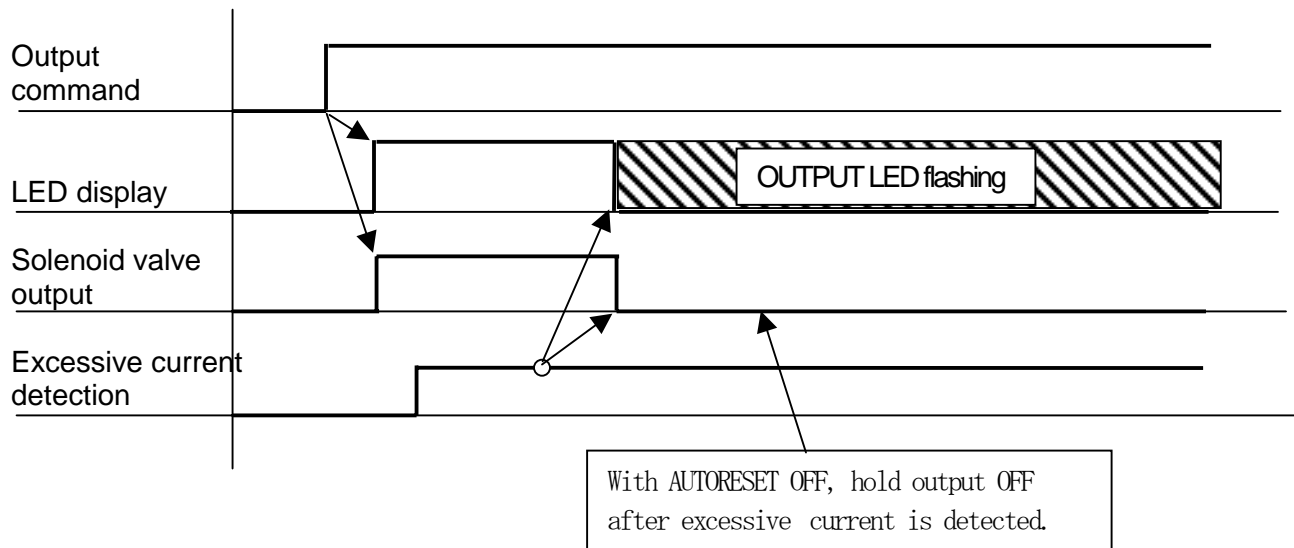

(2) When AUTO RESET ON

- ① Turn ON solenoid valve according to command. (OUTPUT LED steady)
- ② Turn OFF solenoid valve when output excessive current occurs. (OUTPUT LED flashing)
- ③ When the cause of excessive current is removed, solenoid valve recovers its normal output.

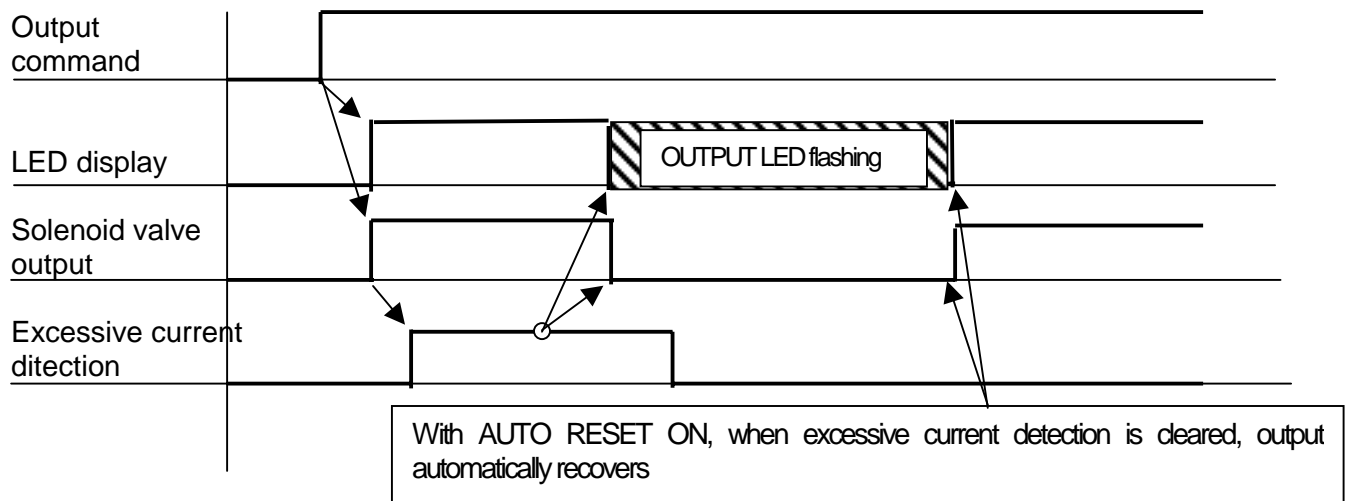

8. Maintenance

● 8 – 1 Procedure to exchange SI unit

SI unit and valve manifold are connected with internal connector.

Also SI unit is attached with screws (4 pieces).

Replacement procedures of SI unit are shown below.

- (1) Make sure that SI unit is not supplied with power.
- (2) Remove all cables connected to the SI unit.
(The cables to be removed are usually bus cable and power cable.)
- (3) Remove hex socket head screws (4pieces) with wrench.
- (4) Pull SI unit upward(display surface side) from bottom, and remove it.
- (5) Adjust SW setting of SI unit to exchange, and mount with the reverse procedures.

Please refer to Figure 4.1 for the positions of each connector and screws.

● 8 – 2 Procedure to exchange fuse

Viewing SI unit from bottom side, there are internal connectors as well as two fuses.

Remove SI unit in the same way as the replacement procedures of SI unit and pull the fuses toward the bottom side to remove.

Please refer to Figure 4.1 for locations of fuses.

(Note) Fuses are built-in to avoid fire when internal circuit is shorted.
Also it is necessary to protect SI unit from external surge voltage and current.
Please use specified fuses.

FUSE BUS : 3961200044 made by WICKMANN (Rated 2.0A)

FUSE VLV PWR : 3961315044 made by WICKMANN (Rating 3.15A)

9. Map for system control

●9-1 I/O assignment

Item		Output	Input	
Occupied byte		2byte (solenoid valve output)	2byte (short status input)	
Send/ receive data	Output Address+0byte	Output No. 0 ~ 7	/	
	+1byte	Output No. 8 ~ 15		
	Input Address +0byte			Short status No.0 ~ 7
	+1byte			Short status No.8 ~ 15

Assignment method of I/O varies according to PLC. Please refer to PLC's operation manual for details.

●9-2 Bit mapping

I/O	Item	Classification	SIGNAL NAME	BIT ADDRESS
Output	Word 1	Solenoid valve	OUT_0 ~ 15	Nxx:O00 ~ 15
Input	Word 1	Circuit protection status	STS_0 ~ 15	Nxx:I00 ~ 15

*OUT_0 is mapped to LSB and OUT_15 is mapped to MSB. For other bits, mapping is done in the same way.

Details of bit mapping

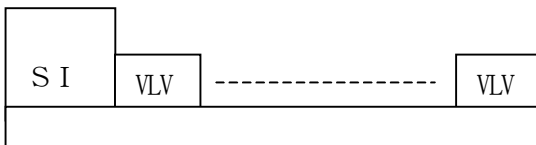

I/O	Item	Classification	SIGNAL NAME	BIT ADDRESS
Output	Word 1	Solenoid valve	OUT_0 ~ 15	Nxx:O00 ~ 15
Input	Word 1	Circuit protection status	STS_0 ~ 15	Nxx:I00 ~ 15

OUT_0 is mapped to LSB and OUT_15 is mapped to MSB. For other bits, mapping is done in the same way.

● 9-3 GSD file

[1] GSD file for SW mode.

```
=====
;GSD-File for SMC SI-Unit(SI Valve Manifold) EX230-SPR1 SW 16O/16I
;Name: SMC_140A.GSD
;Version: 1.1
;Date: 20.04.01
=====
;
;#Profibus_DP
GSD_Revision = 1
Vendor_Name = "SMC Pneumatic"
Model_Name = "EX230-SPR1(SW)"
Revision = "V1.1"
Ident_Number = 0x140A
Protocol_Ident = 0
Station_Type = 0
FMS_supp = 0
Hardware_Release = "1"
Software_Release = "1"
;
9.6_supp = 1
19.2_supp = 1
93.75_supp = 1
187.5_supp = 1
500_supp = 1
1.5M_supp = 1
3M_supp = 1
6M_supp = 1
12M_supp = 1
MaxTsdr_9.6 = 60
MaxTsdr_19.2 = 60
MaxTsdr_93.75 = 60
MaxTsdr_187.5 = 60
MaxTsdr_500 = 100
MaxTsdr_1.5M = 150
MaxTsdr_3M = 250
MaxTsdr_6M = 450
MaxTsdr_12M = 800
;
Redundancy = 0
Repeater_Ctrl_Sig = 2
24V_Pins = 0
Implementation_Type = "LSPM2"
;
Freeze_Mode_supp = 1
Sync_Mode_supp = 1
Auto_Baud_supp = 1
Set_Slave_Add_supp = 1
User_Prm_Data_len = 5
User_Prm_Data = 0x00,0x00,0x00,0x00,0x00
Max_Diag_Data_Len = 13
Min_Slave_Intervall = 1
Slave_Family = 3
Modular_Station = 0
Modul_Offset = 0
Max_Module = 1
Max_Input_Len = 2
Max_Output_Len = 2
Max_Data_Len = 4
;
Module = "DP-Kompaktgeraet 16A/16E" 0xA1,0x91
EndModule
```

[2] GSD file for HW mode.

```
=====
;GSD-File for SMC SI-Unit(SI Valve Manifold) EX230-SPR1 HW 16O/16I
;Name: SMC_140B.GSD
;Version: 1.1
;Date: 20.04.01
=====
```

```
;
#Profibus_DP
GSD_Revision = 1
Vendor_Name = "SMC Pneumatic"
Model_Name = "EX230-SPR1(HW)"
Revision = "V1.1"
Ident_Number = 0x140B
Protocol_Ident = 0
Station_Type = 0
FMS_supp = 0
Hardware_Release = "1"
Software_Release = "1"
;
9.6_supp = 1
19.2_supp = 1
93.75_supp = 1
187.5_supp = 1
500_supp = 1
1.5M_supp = 1
3M_supp = 1
6M_supp = 1
12M_supp = 1
MaxTsdr_9.6 = 60
MaxTsdr_19.2 = 60
MaxTsdr_93.75 = 60
MaxTsdr_187.5 = 60
MaxTsdr_500 = 100
MaxTsdr_1.5M = 150
MaxTsdr_3M = 250
MaxTsdr_6M = 450
MaxTsdr_12M = 800
;
Redundancy = 0
Repeater_Ctrl_Sig = 2
24V_Pins = 0
Implementation_Type = "LSPM2"
;
Freeze_Mode_supp = 1
Sync_Mode_supp = 1
Auto_Baud_supp = 1
Set_Slave_Add_supp = 0
User_Prm_Data_len = 5
User_Prm_Data = 0x00,0x00,0x00,0x00,0x00
Max_Diag_Data_Len = 13
Min_Slave_Intervall = 1
Slave_Family = 3
Modular_Station = 0
Modul_Offset = 0
Max_Module = 1
Max_Input_Len = 2
Max_Output_Len = 2
Max_Data_Len = 4
;
Module = "DP-Kompaktgeraet 16A/16E" 0xA1,0x91
EndModule
```



3011 North Franklin Road Indianapolis, IN 46226, U.S.A

Phone: 317-899-4440 Fax: 317-899-3102 URL: <http://www.smcusa.com/>

Branch offices/ Atlanta, Charlotte, Tampa, Nashville, Richmond, Boston, New Jersey, Rochester, Binghamton
Cincinnati, Cleveland, Columbus, Detroit, Indianapolis, Austin, Dallas, Houston, Tulsa, Los Angeles, Phoenix,
Portland, San Diego, San Francisco, Seattle, Denver, Chicago, Minneapolis, St. Louis, Milwaukee

Specifications are subject to change without prior notice

and any obligation on the part of the manufacture.

EX230-SPR1