



Installation and Maintenance Manual

SI unit - DeviceNet compatible

Type EX230-SDN1



1 Safety Instructions

- This manual contains essential information for the protection of users and others from possible injury and/or equipment damage.
- Read this manual before using the product, to ensure correct handling, and read the manuals of related apparatus before use.
- Keep this manual in a safe place for future reference.
- These instructions indicate the level of potential hazard by label of "DANGER", "WARNING" or "CAUTION", followed by important safety information which must be carefully followed.
- To ensure safety of personnel and equipment the safety instructions in this manual and the product catalogue must be observed, along with other relevant safety practices.

⚠ DANGER	In extreme conditions, there is a possibility of serious injury or loss of life.
⚠ WARNING	If instructions are not followed there is a possibility of serious injury or loss of life.
⚠ CAUTION	If instructions are not followed there is a possibility of injury or equipment damage.

1 Safety Instructions (continued)

Do not bend, apply tensile force, or apply force by placing heavy loads, on the cables.

Connect wires and cables correctly, and do not connect while the power is ON.

Do not route wires and cables together with power or high-voltage cables.

Check the insulation of wires and cables.

Take proper measures against noise, such as noise filters, when the product is incorporated in equipment or devices.

Select the required protection (IP) rating according to the environment of operation.

Take sufficient shielding measures when the product is to be used in the following conditions:

- where noise due to static electricity is generated.
- where electro-magnetic field strength is high.
- where radioactivity is present.
- where power lines are located.

Do not use the product in a place where electric surges are generated.

Use suitable surge protection when a surge generating load such as a solenoid valve is to be directly driven.

Prevent any foreign matter from entering this product.

Do not expose the product to vibration or impact.

Use the product within the specified ambient temperature range.

Do not expose the product to any heat radiation.

Use a precision screwdriver with flat blade to adjust the DIP switch.

Close the cover over the switches before power is applied.

Do not clean the product with chemicals such as benzene or thinners.

2 Specifications

General specifications

Item	Specification
Protection class	IP65 to IEC60529 (NEMA4)
Operating ambient temperature	+5 to +45°C
Operating ambient humidity	35 to 85%RH (no condensation)
Vibration resistance	5G (10 to 55Hz at amplitude 0.50mm)
Shock resistance	Peak acceleration 10G
Voltage resistance	Between external terminal package and case, AC1000V, 50/60Hz, 1 minute
Isolation resistance	Between external terminal package and case, 10MΩ
Environment	No corrosive gas. No dust.

Communication specification

Item	Specification
Applicable system	DeviceNet
Node address	0 to 63
Communication speed	125k, 250k, 500kbit/sec

3 Outline dimensions (mm)

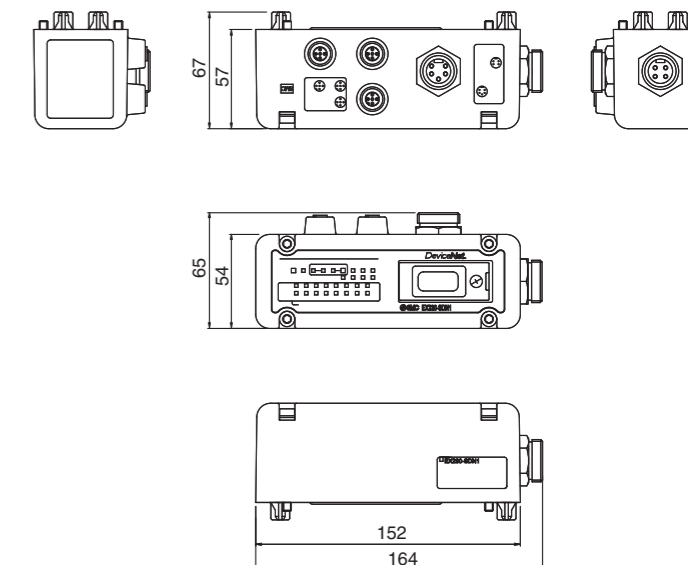

⚠ WARNING

- Do not disassemble, modify (including change of printed circuit board) or repair the product.**

An injury or product failure may result.

- Do not operate the product beyond the specification range.**

Fire, malfunction or equipment damage may result. Use the product only after confirming the specifications.

- Do not use the product in the presence of flammable, explosive or corrosive gas.**

Fire, explosion or corrosion may result. This product does not have an explosion proof construction.

- When using the product as part of an interlocking system:**

1) Provide a double interlocking system, for example a mechanical system.

2) Check the product regularly to ensure proper operation.

- Before performing maintenance, be sure of the following:**

1) Turn off the power supply.

2) Stop the air supply, exhaust the residual pressure and verify the release of air from the system.

⚠ CAUTION

- Always perform a system check after maintenance.**

Do not use the product if any error occurs.

Safety cannot be assured if caused by un-intentional malfunction.

- Provide grounding to ensure correct operation and to improve noise resistance of the product.**

This product should be individually grounded using a short cable.

- Follow the instructions given below when handling the product. Failing to do so may result in product damage.**

Maintenance space should always be provided around the product.

Do not remove labels from the product.

Do not drop, hit or apply excessive shock to the product.

Follow all specified tightening torques.

• Power Supply selection

A UL approved direct current (DC) power supply should be used with this product, as follows:

- A limited voltage / current supply in accordance with UL508.

A circuit from which power is supplied by the secondary coil of a transformer according to the following:

Maximum voltage (no load) : Less than 30Vrms (42.4V peak)

Maximum current : (1) Less than 8A (including when short circuited)

(2) Limited by circuit protection (such as a fuse) with the following rating.

No load voltage (V peak)	Max. current (A)
0 to 20 [V]	5.0
20 to 30 [V]	100 / peak voltage

- A Class 2 power supply unit in accordance with UL1310, or a power supply circuit of maximum 30Vrms (42.4V peak) or less, using a Class 2 transformer in accordance with UL1585 as power source.

SI unit specification

Item	Specification
Output points	16 points
Output type	PNP transistor, open collector type (with over current protection)
Connection load	Solenoid valve with 24VDC, 2.8W or less of light and surge voltage protection
Input points	32 points
Input contents	0 to 15 : Over current detection status
	16 : PWR VLV status
	17 to 21 : Sensor input
	22, 23 : EPR input
Power supply voltage, consumption current	24 to 31 : Not used
	11 to 25VDC (for DeviceNet), 0.5A(Max): with sensor not connected
	20 to 25VDC (for DeviceNet), 0.5A(Max): with sensor connected
Weight	20 to 26.4VDC (for Solenoid valve), 2.0A(Max)
	600g or less
External dimensions (D x W x H)	65 x 164 x 57

4 Names / Functions of Individual Parts

- Input connector
To connect the sensors.
- Communication connector
To send and receive communication signals through DeviceNet line.
- Output equipment connector
To connect the output equipment such as a solenoid valve.
- Power supply connector for output equipment
To supply power to the output equipment such as a solenoid valve.
- Indication and address setting panel
To provide LED's to indicate the condition of the unit and the setting of address, Hold / Clear functions and auto reset functions.

• Fuse

In the power supply for the sensor SI unit and output equipment, if an over current flows because of short circuit etc., the power supply will be disconnected by the fuse.

In this case, the user must fix the cause of the short circuit before exchanging the fuse.

4 Names / Functions of Individual Parts (continued)

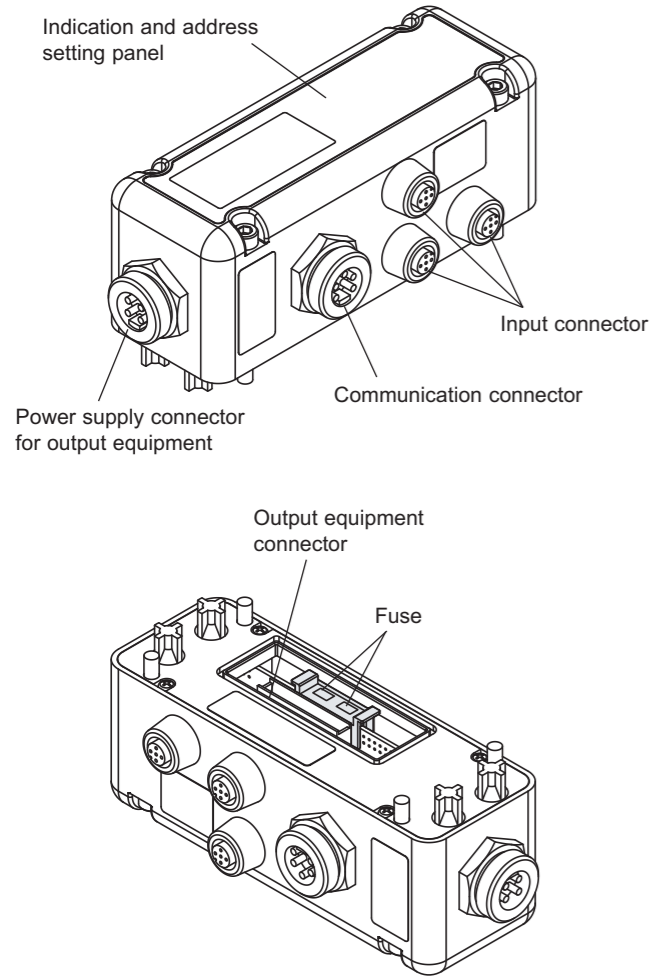

LED indication

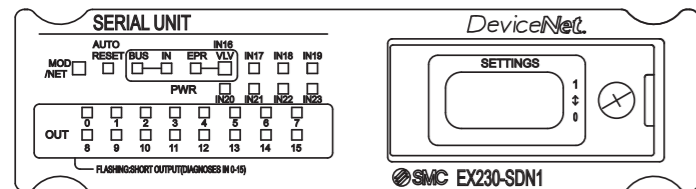

Indication	Contents
MOD / NET	Displays the status of communication to DeviceNet
AUTORESET	When shorted at the output, the output turns OFF. When the SI unit recovers automatically, this LED will remain steady.
PWR BUS	Displays the power supply status supplied to the DeviceNet.
PWR IN	Displays the power supply status supplied to the Sensors.
PWR EPR	Displays the power supply status supplied to the EPR.
PWR VLV	Displays the power supply status supplied to the Solenoid valve.
IN 17 to 21	Displays the status of the Sensor inputs.
IN 22, 23	Displays the status of the EPR input.
OUT 0 to F	Display the status of the Outputs.

5 Wiring

BUS connector specification

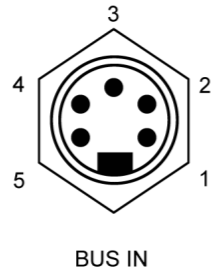

No.	Description	Function
1	Drain / Shield	Drain / Shield
2	V+	Power supply + for circuit
3	V-	Power supply - for circuit
4	CAN_H	Signal wire H
5	CAN_L	Signal wire L

VLV PWR IN connector specification

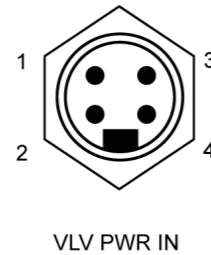

No.	Description	Function
1	24V	For solenoid valve +24VDC
2	NC	No connection
4	NC	No connection
6	0V	For solenoid valve 0V

5 Wiring (continued)

Connector description : 5-pin connector (M12) Female

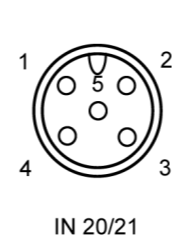

No.	Description	Function
1	24V DC (for sensor)	24VDC for sensor
2	IN 21	Sensor 21 input signal
3	0V (for sensor)	0V for sensor
4	IN 20	Sensor 20 input signal
5	PE (Protective Earth)	Protective Earth

6 Switch Setting (continued)

Setting of node address(6bit) Setting of communication speed (2bit)

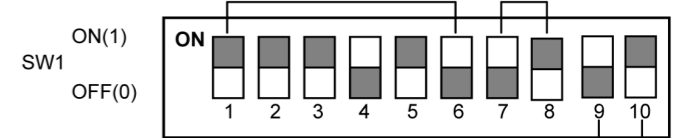

Output specification when communication error is detected. (1bit)
Setting specification of node address and communication speed (1bit)

How to set SW2

SW2 No.	1	2	3	4
AUTORESET	OFF 0			
	ON 1			
RESERVE	OFF	0		
RESERVE	OFF		0	
RESERVE	OFF			0

Setting of recovery from over current protection

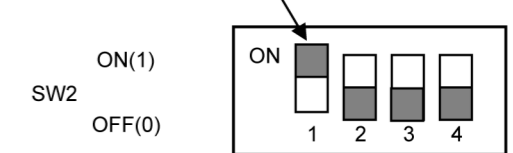

6 Switch Setting

Address setting

When DIP switches are to be set, turn OFF power supply to SI unit. 2x DIP switches (SW1:10bit,SW2:4bit) are mounted under the display of the SI unit.

To set switches, remove the fixing screw for the switch cover, open cover and set each switch. Replace cover after setting.

How to set SW1

SW1 No.	1	2	3	4	5	6	7	8	9
Node address	1	2	4	8	16	32			
	0	0	0	0	0	0			
	1	1	0	0	0	0			
	2	0	1	0	0	0	0		
Communication speed (BAUD RATE)	62	0	1	1	1	1	1		
	63	1	1	1	1	1	1		
	125k						0	0	
	250k						1	0	
Output specification when communication error is detected.	500k						0	1	
	---						1	1	
Setting mode	CLEAR								0
	HOLD								1
Setting mode	HW								0
	SW								1

7 Contacts

AUSTRIA	(43) 2262 62280	NETHERLANDS	(31) 20 531 8888
BELGIUM	(32) 3 355 1464	NORWAY	(47) 67 12 90 20
CZECH REP.	(420) 541 424 611	POLAND	(48) 22 211 9600
DENMARK	(45) 7025 2900	PORTUGAL	(351) 21 471 1880
FINLAND	(358) 207 513513	SLOVAKIA	(421) 2 444 56725
FRANCE	(33) 1 6476 1000	SLOVENIA	(386) 73 885 412
GERMANY	(49) 6103 4020	SPAIN	(34) 945 184 100
GREECE	(30) 210 271 7265	SWEDEN	(46) 8 603 1200
HUNGARY	(36) 23 511 390	SWITZERLAND	(41) 52 396 3131
IRELAND	(353) 1 403 9000	UNITED KINGDOM	(44) 1908 563888
ITALY	(39) 02 92711		

SMC Corporation

URL <http://www.smworld.com> (Global) <http://www.smceu.com> (Europe)

Specifications are subject to change without prior notice from the manufacturer.
© SMC Corporation All Rights Reserved.