



Installation & Maintenance Manual Input Block

Type EX250-IE1

EX250-IE2

EX250-IE3



Safety Instructions

The unit and this manual contain essential information to protect users and others from possible injury and property damage and to ensure correct handling. Please confirm that you fully understand the meaning of the following messages (signs) before reading the text, and always follow the instructions. Please read the Installation & Maintenance Manual for related apparatus and understand it before operating the actuator.

IMPORTANT MESSAGES

Read this manual and follow the instructions. Signal words such as WARNING, CAUTION and NOTE, will be followed by important safety information that must be reviewed carefully.

⚠WARNING	Indicates a potentially hazardous situation which could result in death or serious injury if you do not follow instructions.
⚠CAUTION	Indicates a potentially hazardous situation which if not avoided, may result in minor injury or moderate injury.
NOTE	Provides you helpful information.

⚠WARNING

Do not disassemble, modify (including change of printed circuit board) or repair.

An injury or failure can result.

Do not operate outside of the specification range.

Fire, malfunction or damage can result.

Please use it after confirming the specification.

Do not use the product in environments with possible presence of flammable, explosive or corrosion gas.

Otherwise fire, explosion or corrosion can result.

The product is not designed to be explosion proof.

Do not apply voltages exceeding 250V between a lead wire and a metal fitting.

Pay attention to perform an insulation test because it could damage the insulation of the lead wire and cause failure.

Safety Instructions (continue)

These instructions must be followed when using the product in an interlocking circuit:

·Provide double interlocking through another system such as mechanical protection.

·Check the product regularly to ensure proper operation.

Otherwise malfunction can cause an accident.

These instructions must be followed when performing maintenance work:

·Turn off the power supply

·Stop the air supply, exhaust the residual pressure and verify that the air is released before performing maintenance work.

Otherwise it can cause injury.

⚠CAUTION

Perform a proper functional check after completing maintenance work.

Stop operation when an abnormality is observed or the product is not working properly.

Safety cannot be assured due to unexpected malfunctions.

NOTE

The direct-current power supply should be a UL authorized power supply.

1.Limited voltage current circuit in accordance with UL508

A circuit to which power is supplied by the secondary coil of a transformer that meets the following conditions.

- Max. voltage (with no load) : less than 30Vrms (42.4V peak)
- Max. current : (1) less than 8A (including when short circuited)
(2) limited by circuit protector (such as fuse) with the following ratings

No load voltage (V peak)	Max.current rating (A)
0 to 20 [V]	5.0
20 to 30 [V]	100 / peak voltage

2.UL1310 compatible class 2 power supply unit or circuit of max. 30Vrms (42.4V peak) or less using a UL1585 compatible class 2 transformer as power supply. (Class 2 circuit)

Follow the instructions given below when handling the product.

Failure to follow instructions may damage the unit.

·Operate the product within the specified voltage range.

·Reserve a space around the unit for maintenance.

·Do not remove labels.

·Do not drop, hit or apply excessive shock to the product.

·Do not bend or apply tensile force to cables, or apply a force by placing a heavy load on them.

·Connect wires and cables correctly.

·Do not connect wires while the power is on.

·Do not lay wires or cables with the same wiring route as a power line or high-voltage line.

·Verify the insulation of the wiring.

·Take proper measures against noise such as a noise filter when the product is incorporated in equipment or devices.

·Select an operation environment according to enclosure (IP67).

·Take sufficient shielding measures when installing the product at the following place.

(1) A place where a noise due to static electricity etc. is generated

(2) A place of high electric field strength

(3) A place possibly exposed to radioactivity

(4) A place near power cable

·Do not use the product nearby a place where an electric surge is generated.

·Prevent foreign matter such as remnant of wires from entering the product.

·Do not expose the product to vibration and impact.

·Keep the specified ambient temperature range (+5 to +45°C).

·Do not expose the product to heat radiation from a heat source located nearby.

·Perform maintenance and check at regular intervals.

·Perform a proper functional check.

·Do not clean the product with chemicals such as benzene and thinner.

Specification

General Specification

Item	Specification
Operating ambient temperature	+5 to +45°C
Operating ambient humidity	35 to 85%RH (No dew condensation)
Storage ambient temperature	-20 to +60°C
Vibration proof	10 to 57Hz 0.35mm (constant amplitude) 57 to 150Hz 50m/s ² (constant acceleration)
Impact proof	150m/s ² (peak), 11ms × three times in each direction ±X, Y and Z
Noise immunity	Normal mode : 1500V Pulse duration 1μs Common mode : 1500V Pulse duration 1μs Radiation : 1000V Pulse duration 1μs
Operating environment	No corrosive gas and no dust

Input Specification

Item	Specification		
Rated voltage Ue	24VDC *2		
Part number	EX250-IE1	EX250-IE2	EX250-IE3
Input point	2 points	4 points	4 points
Input connector	M12 connector	M12 connector	M8 connector
Standard	IEC1131-2		
Corresponding sensors	Current source type (PNP output) Current sink type (NPN output) *1		
Logic "1" input voltage UH	+11 to +30V DC		
Logic "0" input voltage UL	-3 to +5V DC		
Logic "1" input current IH	8mA Typ.		
Two wire sensor connection	Possible		
Logic "0" allowable current IL	2.5mA Max.		
Sensor supply current	120mA/Input Block (30mA/sensor) *3		
Short-circuit protection	500mA Fuse for each Input Block		

*1) Change-over by switch (for changing the whole Input Block)

*2) Approx. 1V of voltage drop for power supply voltage (power for SI unit and Input Block)

*3) For extended Input Blocks and where 32 sensors are used, total of sensor supply current should not exceed 1A.

Outline with Dimensions (in mm)

EX250-IE1

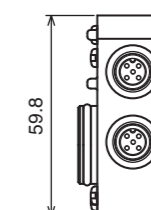
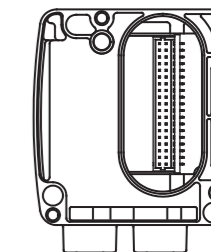
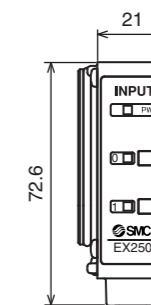

EX250-IE2

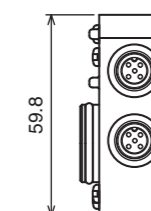
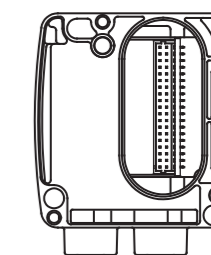
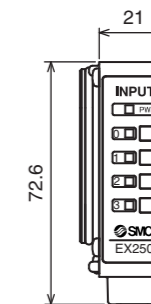

EX250-IE3

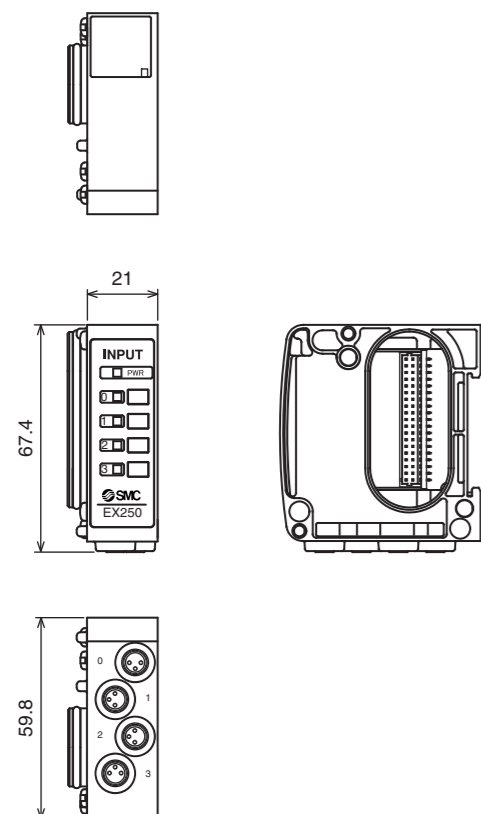

LED indication

EX250-IE1

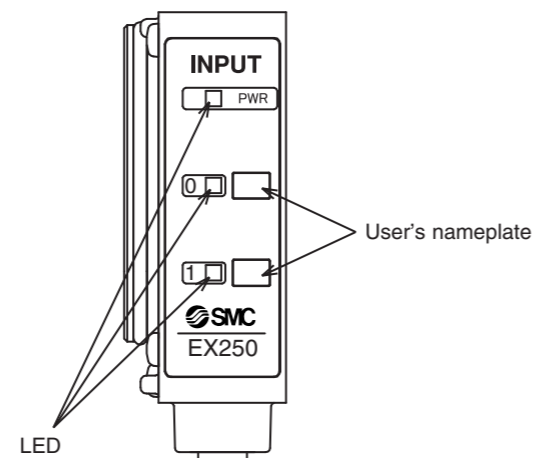

Indication	Contents
PWR (Green)	Light ON when input power is on.
0 (Yellow)	Light ON when sensor 0 input signal is on.
1 (Yellow)	Light ON when sensor 1 input signal is on.

Input selector switch

Setting for the sensor input is "PNP" when units are shipped from the factory.

When connecting NPN sensor, please change the setting from PNP to NPN by selector switch as shown in the picture below. The Input manifold must be dis-assembled into individual Input Blocks to change the switch position.

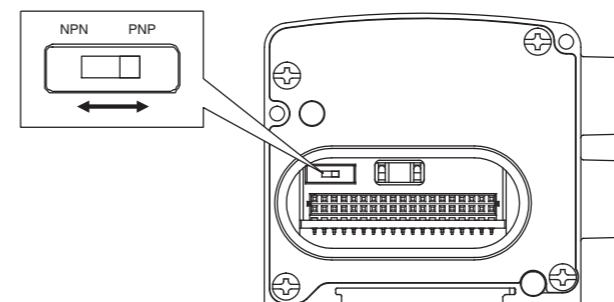

Connector

EX250-IE1

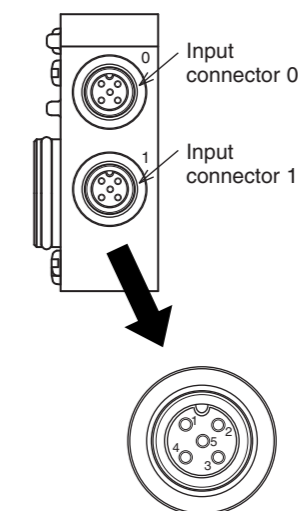

Input connector 0

Pin No.	Description	Function
1	24V	Sensor supply power +
2	IN1	Sensor 1 input signal
3	0V	Sensor supply power -
4	IN0	Sensor 0 input signal
5	E	Earth

Input connector 1

Pin No.	Description	Function
1	24V	Sensor supply power +
2	-	Unused
3	0V	Sensor supply power -
4	IN1	Sensor 1 input signal
5	E	Earth

Pin No.2 of Input connector 0 and Pin No.4 of Input connector 1 are connected inside the Input Block.

This enables the user to use two different inputs by using a single Input connector 0 and reduces the cost of wiring.

To ensure the IP67 rating, please use a waterproof plug on unused Input connector 1.

Body

Input connector 0, 1

To connect the sensor.

SI unit connector

To connect the SI unit.

Input block connection connector

To connect the Input block.

Indication

LED to indicate the condition of the unit.....

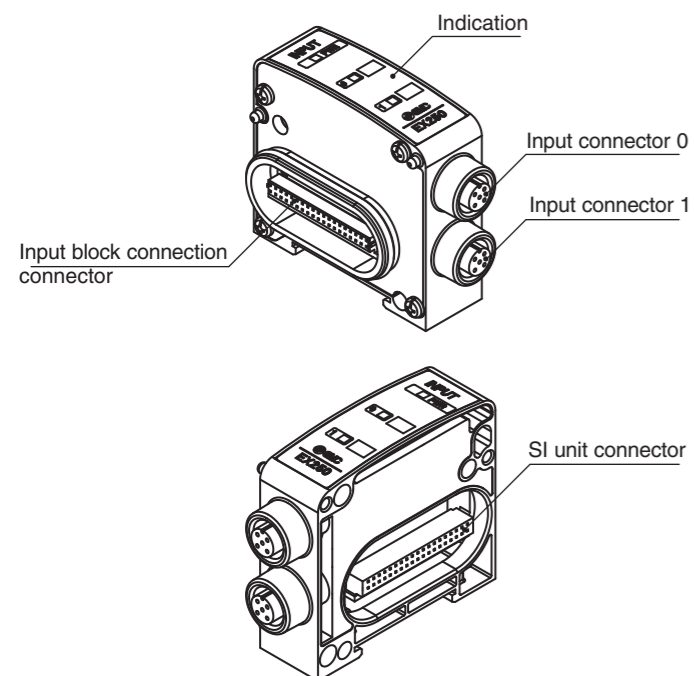

EX250-IE2, 3

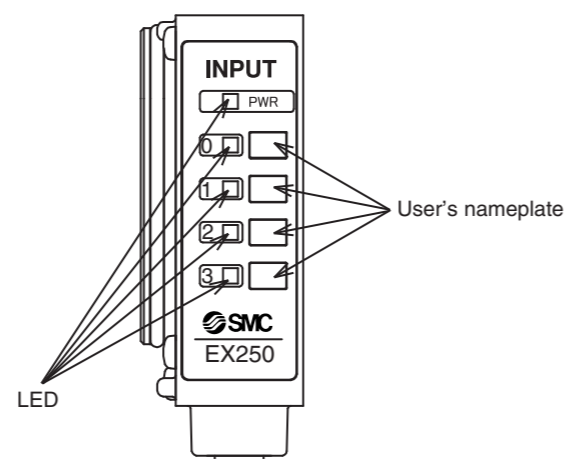

Indication	Contents
PWR (Green)	Light ON when input power is on.
0 (Yellow)	Light ON when sensor 0 input signal is on.
1 (Yellow)	Light ON when sensor 1 input signal is on.
2 (Yellow)	Light ON when sensor 2 input signal is on.
3 (Yellow)	Light ON when sensor 3 input signal is on.

Input current

The available current to the sensor is 30mA maximum for each input point.

In the power supply for the sensor, if an over current flows because of short circuit etc, the power supply will be cut-off by the fuse.

In this case, the user must fix the cause of the short circuit before exchanging the fuse.

The Input manifold must be dis-assembled into individual Input Blocks to exchange the fuse.

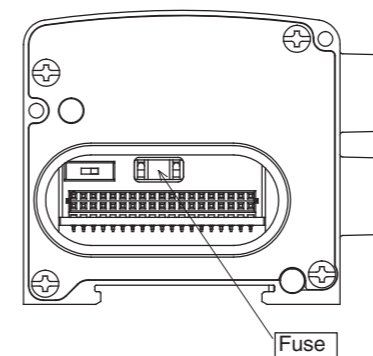

EX250-IE2

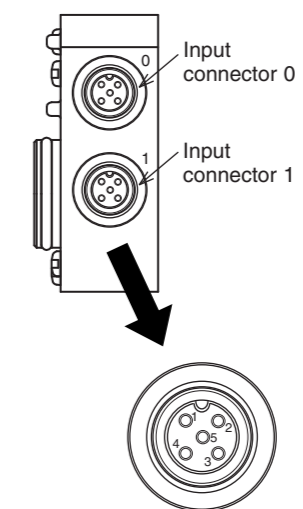

Input connector 0

Pin No.	Description	Function
1	24V	Sensor supply power +
2	IN1	Sensor 1 input signal
3	0V	Sensor supply power -
4	IN0	Sensor 0 input signal
5	E	Earth

Input connector 1

Pin No.	Description	Function
1	24V	Sensor supply power +
2	IN3	Sensor 3 input signal
3	0V	Sensor supply power -
4	IN2	Sensor 2 input signal
5	E	Earth

To ensure the IP67 rating, please use a waterproof plug on unused Input connector.

EX250-IE3

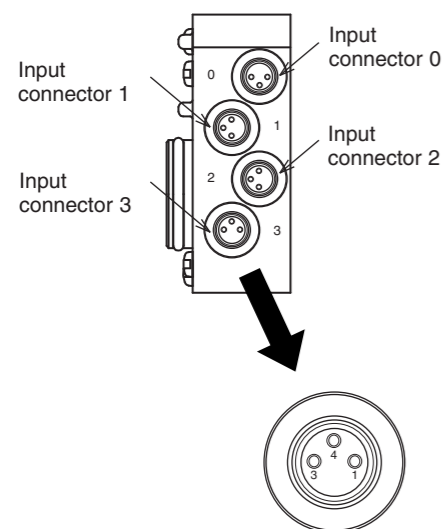

Input connector 0, 1, 2, 3

Pin No.	Description	Function
1	24V	Sensor supply power +
2	IN	Sensor input signal
3	0V	Sensor supply power -

To ensure the IP67 rating, please use a water proof plug on unused Input connector.

Error Display Function

PWR LED	Power ON/OFF LED
Green Light OFF Pale green Light ON	<Countermeasures> Confirm fuse breakage of Input Block. Confirm input power (24V) of SI unit. If above countermeasures do not improve status, please exchange SI unit, Input
0 to 3 LED	Input signal ON/OFF LED
No Lights ON No Lights OFF	<Countermeasures> Confirm correct connection. Confirm the type of sensors (PNP/NPN). If above countermeasures do not improve status, please confirm after reversing the sensors, exchange Input Block.●●

Contact

AUSTRIA	(43) 2262 62280	NETHERLANDS	(31) 20 531 8888
BELGIUM	(32) 3 355 1464	NORWAY	(47) 67 12 90 20
CZECH REP.	(420) 541 424 611	POLAND	(48) 22 211 9600
DENMARK	(45) 7025 2900	PORTUGAL	(351) 21 471 1880
FINLAND	(358) 207 513513	SLOVAKIA	(421) 2 444 56725
FRANCE	(33) 1 6476 1000	SLOVENIA	(386) 73 885 412
GERMANY	(49) 6103 4020	SPAIN	(34) 945 184 100
GREECE	(30) 210 271 7265	SWEDEN	(46) 8 603 1200
HUNGARY	(36) 23 511 390	SWITZERLAND	(41) 52 396 3131
IRELAND	(353) 1 403 9000	UNITED KINGDOM	(44) 1908 563888
ITALY	(39) 02 92711		

SMC Corporation

URL <http://www.smcworld.com> (Global) <http://www.smceu.com> (Europe)

Specifications are subject to change without prior notice from the manufacturer.
© SMC Corporation All Rights Reserved.