



Installation & Maintenance Manual

Reduced wiring system

PROFIBUS-DP Compatible GW Unit

Type EX500-GPR1A-X20



Safety Instructions

The body of unit and this manual contain the essential information for the protection of users and others from possible injury and property damage and to ensure correct handling.

Please check that you fully understand the definitions of the following messages (symbols) before going on to read the body of this manual, and always follow the instructions.

Please also read the instruction manuals etc. of related machines and understand the contents before use.

IMPORTANT MESSAGES

Read this manual and follow its instructions. Signal words such as WARNING, CAUTION and NOTE will be followed by important safety information that must be carefully reviewed.

⚠WARNING	Indicates a potentially hazardous situation that could result in death or severe injury if you do not follow instructions.
⚠CAUTION	Indicates a potentially hazardous situation that, if not avoided, may result in minor injury or moderate injury.
NOTE	Gives you helpful information.

⚠WARNING

Do not disassemble, modify (including modification of printed circuit board) or repair.
Otherwise injury or failure can result.

Do not operate beyond specification range.

Otherwise fire, malfunction or damage to the reduced wiring system can result. Confirm the specifications before operation.

Do not operate in atmosphere of flammable/explosive/corrosive gas.

Otherwise fire, explosion or corrosion can result.
This reduced wiring system is not explosion-proof type.

For use in interlock circuit:

Provide double interlock system by adding different type of protection

(such as mechanical protection).

Check that the interlock circuit is working normally.

Otherwise accident caused by malfunction can result.

Before performing maintenance:

• **Turn off power supply.**

• **Stop air supply, exhaust compressed air in piping, and confirm the release to atmosphere.**

Otherwise injury can result.

Safety Instructions (continue)

⚠CAUTION

Conduct proper functional inspection after completing maintenance.

In the case of abnormality such as unit does not work normally, stop the operation. Otherwise safety cannot be assured due to unintended malfunction.

Provide grounding to improve safety and noise resistance of reduced wiring system.

Provide grounding as close to the unit as possible to shorten distance for grounding.

NOTE

● Handling precautions

Use the following UL-recognized DC power supply to combine with.

- UL508-compatible limited voltage/current circuit
A circuit using the secondary coil of an insulating transformer that meets following conditions as power source.
 - Maximum voltage (at no load) : 30Vrms (42.4Vpeak) or below
 - Maximum current: (1) 8A or less (including when short-circuited)
(2) When limited by the circuit protector (such as fuse) having the following rating.

No-Load Voltage (Vpeak)	Max. Current Rating (A)
0 to 20 [V]	5.0
Above 20 [V] to 30 [V]	100/peak voltage

- UL1310-compatible Class 2 power supply unit or circuit of max. 30Vrms (42.4Vpeak) or less using a UL1585-compatible Class 2 transformer as power source. (Class 2 circuit)

Follow the instructions given below when handling your reduced wiring system. Otherwise a damage or failure to cause a malfunction can result.

- Operate the reduced wiring system at the specified voltage.
- Reserve space for maintenance.
- Do not remove any name plate or label.
- Do not drop, hit or apply an excessive shock to the unit.
- Follow the specified tightening torque.
- Do not apply any excessive force to cables by repeated bending, tensioning or placing a heavy object on the cables.
- Connect wires and cables correctly.
- Do not perform any wiring work while the power is on.
- Do not use the reduced wiring system on the same wiring route as the power line or high voltage line.
- Confirm the insulation of wiring.
- Perform the power supply wiring by dividing into two lines — one is for power supply for output and the other is for power supply for input and controlling GW/SI.
- Take sufficient measures against noise such as noise filter when incorporating the reduced wiring system into a machine or equipment.
- Mount a terminal plug or a waterproof cap on each unused M12 connector for input/output (communication connector, communication ports A - D, and power supply for input and controlling GW/SI).
- Take sufficient shielding measures when operating the product in any of the following places.
 - (1) A place where noise due to static electricity etc. is generated
 - (2) A place of high electric field strength
 - (3) A place where exposure to radioactivity is possible
 - (4) A place near power cable
- Do not operate the product in a place where there is a source of surge.
- Use a surge absorbing element built-in type to directly drive the load that generates surge voltage such as solenoid valve.
- Prevent any foreign matter such as remnant of wires from getting inside the product when opening the station number switch protective cover.
- Install the reduced wiring system in a place free from vibration and impact.
- Operate the product in the specified ambient temperature range.
- Do not use in a place to be affected by the radiant heat from a surrounding heat source.
- Set the DIP switch and rotary switch by using a sharp-pointed watchmakers screwdriver etc.
- Perform the maintenance regularly.
- Conduct an appropriate functional inspection after completing the maintenance.
- Do not use chemicals such as benzine and thinner to clean the product.

Specification

● Basic specifications

Rated voltage	24VDC
Range of power supply voltage	Power supply for input and controlling GW/SI: 24VDC ±10% Power supply for output: 24VDC+10%/-5% (Voltage drop warning at around 20V)
Rated current	Power supply for input and controlling GW/SI: Max. 3.0A (Inside GW unit: 0.2A Input device and SI control section: 2.8A) Power supply for solenoid valves and output: Max. 3.0A
Number of input/output points	Input point: Max. 64/Output point: Max. 64

● Higher-level bus

Protocol	PROFIBUS-DP (EN50170)
Transmission rate	9.6/19.2/45.45/93.75/187.5/500kbps, 1.5/3/6/12Mbps
Freeze mode/Sync mode	Supported
ID Number	140E (hexadecimal)

● Lower-level bus

Number of branches for input/output	4 branches (16 points/branch) for input 4 branches (16 points/branch) for output
Communication method	Protocol: Dedicated for SMC Speed: 750kbps
Branch current for input (Note)	Max. 0.5 [A] per branch (when SI unit and input devices are connected)
Branch current for output	Max. 0.65 [A] per branch (when SI unit EX500-S □01 is connected) Max. 0.75 [A] per branch (when SI unit EX500-Q □0 ₂ is connected)
Branch cable length	5m or less between connected units (total extended length per branch: 10m or less)

Note: Total value of maximum current consumption and maximum load current of input devices to connect.

● Diagnosis function

Function	Contents
Solenoid valve power supply voltage monitoring	Detects that solenoid valve voltage has decreased to approx. 20V or less.
Communication port monitoring	Detects that Communication port A to D has not received data.

● User parameter

Parameter	Description
Used / unused of monitoring function for solenoid valve power supply voltage	Set used and unused of mounting for solenoid valve power supply voltage.
Used / unused of monitoring function for communication port	Set used and unused of monitoring function for communication port of diagnosis function in a port basis.

Names and Functions of individual parts

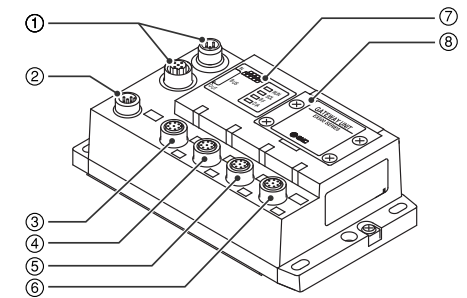

No.	Name	Application
1	Communication connector	Connect with PROFIBUS-DP line. (Note 1)
2	Power supply connector	Supply power for output devices such as solenoid valve, for input devices such as sensor, and for controlling GW/SI by using power supply connector cable. (Note1)
3	Communication port A (COM A)	Connect SI unit (manifold valve) or Input unit by using branch cable with M12 connectors. (Note1)
4	Communication port B (COM B)	
5	Communication port C (COM C)	
6	Communication port D (COM D)	
7	Display	Display the power supply status and communication status with PLC. (Note2)
8	Station number switch protective cover	Set address and bus terminator by using the switches under this cover. (Note2)

Note1: For wiring method, refer to subsection "Wiring" in this manual.

Note2: For display and setting method, refer to subsection "Switch Setting" and "Display" in this manual.

Outline with Dimensions (in mm)

● EX500 body

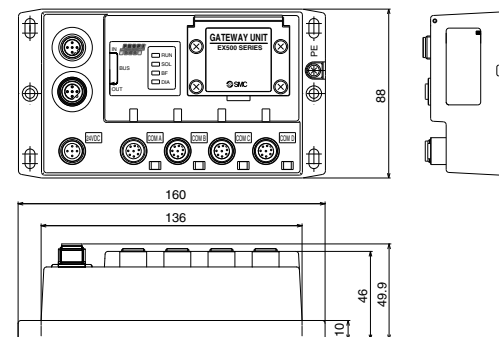

Installation (unit : mm)

●Screw mounting

Secure at four positions with screws with head diameter of 5.2 or more and thread length of 15mm or more.

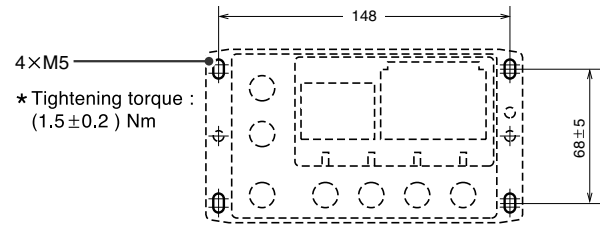

Cutout Dimensions for Mounting (Tolerance: 0.2)

★ Tightening torque :
(1.5±0.2) Nm

Wiring (continue)

The wirings are described in the following order.

① Communication wiring: Connection with PROFIBUS-DP

② Power supply wiring: Connections of power supplies for solenoid valves/output devices, and for input devices and controlling GW/SI

③ Branch wiring: Connection from GW unit to SI unit or Input unit

① Communication wiring

Connect the cable with PROFIBUS-DP communication connector to the communication connector of GW unit.

Cable connection

- Align the key groove with the IN-side communication connector (5-pin, plug) of GW unit, plug in the PROFIBUS-DP communication cable (socket).
- Tighten the lock nut on cable side by turning it clockwise by hand.
- Confirm that the connector portion does not move.
- Similar to the above, connect the other communication cable (plug) to the OUT-side communication connector (5-pin, socket) of GW unit.

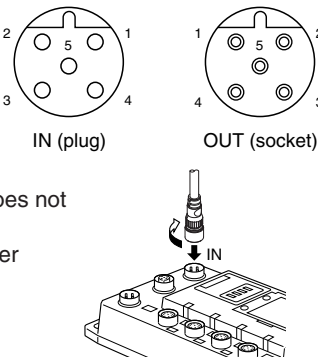

② Power supply wiring

Connect the power supply connector cable to the power supply connector of GW unit. There are two types of cables different in connector shape — straight type and angle type. With this cable, the power is supplied to the output devices such as solenoid valve, and the input devices such as sensor, and for controlling GW/SI. Therefore, there is no need to supply the power to other units individually. When selecting the power supply, refer to "Handling precautions" in this manual.

Cable connection

- Align the key groove with the power supply connector (plug) of GW unit, plug in the power supply cable (socket).
- Tighten the lock nut on cable side by turning it clockwise by hand.
- Confirm that the connector portion does not move.

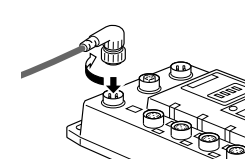

Separate wiring for power supply for solenoid valves/output and for input and control of GW/SI

Both single power supply and two power supply systems can be adopted, however, the wiring shall be made separately (for solenoid valves/output and for input and controlling GW/SI) for either system.

A. Two power supply system

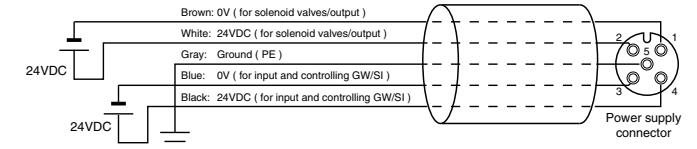

B. Single power supply system

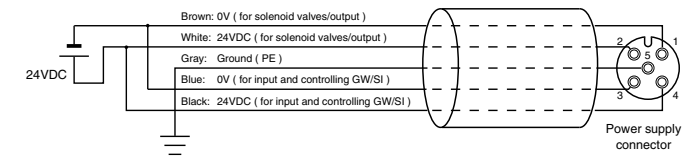

Wiring

●Internal circuit

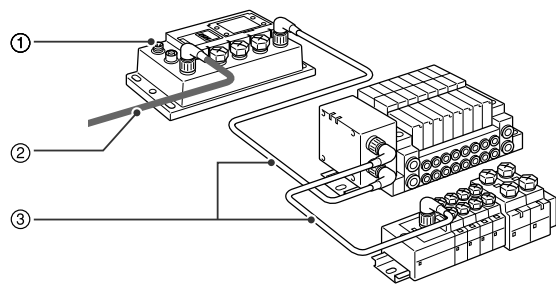
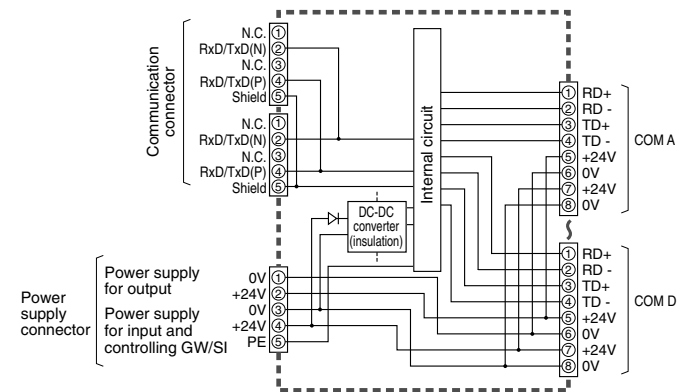

Connection of bus terminator

- To the units at both ends of PROFIBUS-DP system, be sure to connect "bus terminators".
- If the EX500 is an end unit, set the bus terminator. (For how to set, refer to subsection "Switch Setting" and "Display" in this manual.)

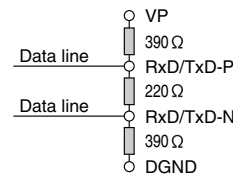

Pin layout and connection diagram of cable with PROFIBUS-DP communication connector

Connect the communication cable with M12 connector to the M12 reverse communication connector. For the cable to use, refer to "Appendix Table" in the Instruction Manual of EX500-GPR1A.

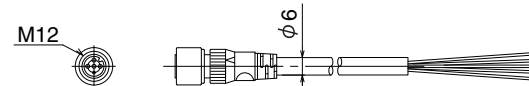

Common to IN side and OUT side

Pin No.	Cable color: Signal name	Pin No.	Cable color: Signal name
1	N.C.: N.C.	4	Red: RxD/TxD(P)
2	Green: RxD/TxD(N)	5	SHIELD: Shield
3	N.C.: N.C.		

Pin layout and connection diagram of power supply connector cable (unit: mm)

(Pin layout and connection diagram are common to all cables.)

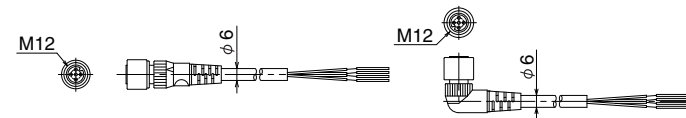

Pin No.	Cable color: Signal name
1	Brown: 0V (for solenoid valves/output)
2	White: DC24V+10%/-5% (for solenoid valves/output)
3	Blue: 0V (for input and controlling GW/SI)
4	Black: DC24V ±10% (power supply for input and controlling GW/SI)
5	Gray: Ground (PE)

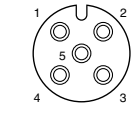

NOTE

Connect a ground cable of 100Ω or less to PE terminal. (The Shield and PE terminal of PROFIBUS-DP are connected inside GW unit through a capacitor.)

③ Branch wiring (wiring to communication ports)

For wiring with solenoid valves or input devices, connect the branch cable with M12 connector to communication ports A - D. There are two types of cables different in connector shape — straight type and angle type. As each cable contains power supply wire, there is no need to supply the power to solenoid valves or input devices individually.

Cable connection

- Align the key groove with the connector (socket) of GW unit, plug in the cable (plug).

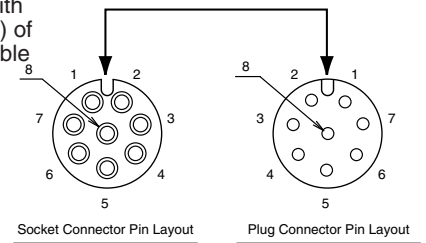

- Tighten the lock nut on cable side by turning it clockwise by hand.
- Confirm that the connector portion does not move.

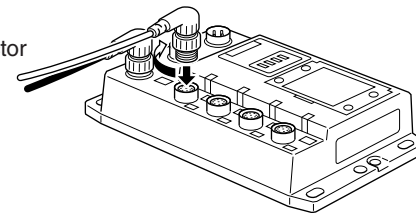

NOTE

Mount a waterproof cap on each unused connector of GW unit. The proper use of waterproof cap can achieve IP65 Enclosure. (Tightening torque: 0.1N·m for M12)

Wiring (continue)

For GW unit – Manifold valve – Input unit manifold configuration

Two communication connectors in SI unit and one communication connector in Input unit are installed respectively. To the communication connector (C2) or (1) of SI unit, connect the branch cable with M12 connector from GW. To the communication connector (C1) or (0), connect the branch cable with M12 connector from Input unit. To the communication connector of Input unit, connect the branch cable with M12 connector from SI unit.

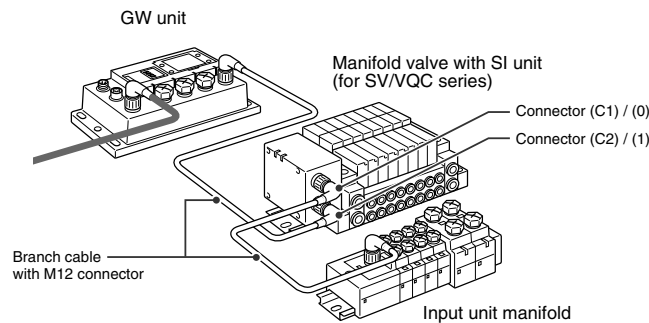

NOTE
When no Input unit is connected to the connector (C1) or (0) of SI unit, mount a terminal plug on the connector.

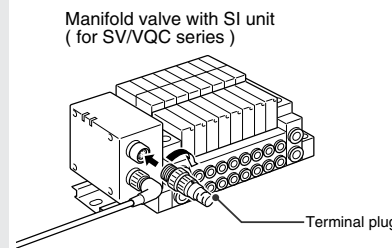

For GW unit – Input unit manifold configuration

To the communication connector of Input unit, connect the branch cable with M12 connector from GW unit.

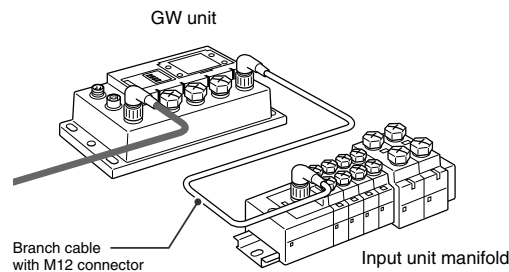

Setting

●Switch setting

Open the station number switch protective cover and set the switches with a fine-pointed watchmakers screwdriver etc.

NOTE

1. Be sure to turn off the power before setting the switches.
2. Be sure to set these switches before use. The factory default settings are all "OFF" or "0".
3. After opening and closing the station number switch protective cover, tighten the screws by proper tightening torque. (Tightening torque: 0.6N·m)

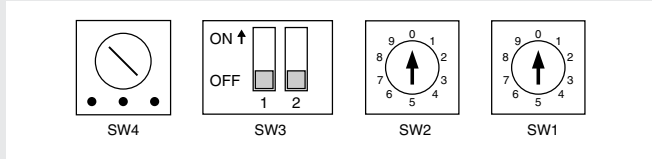

Address setting switches 1, 2 and 3 (SW1, SW2 and SW3)

These switches can set the node address. The settings of each switch are as shown in the table below. Addresses for up to 32 stations (without repeater) or 126 stations (with repeater) can be set per segment.

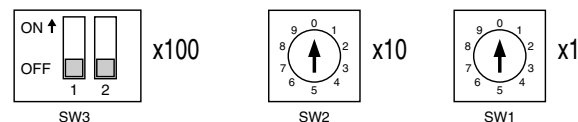

	SW3		SW2	SW1
	1	2		
ON	N.C	1	0...9	0...9
OFF		0		

Bus terminator switch (SW4)

This switch can set the bus terminator.

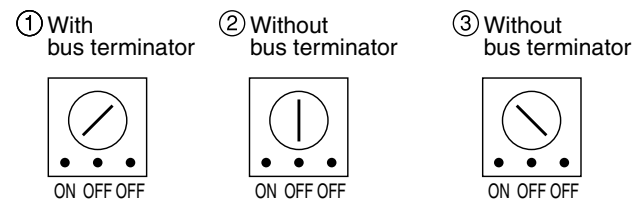

●Layout of the GW unit diagnosis

	Contents							
Byte 0	Station status 1							
Byte 1	Station status 2							
Byte 2	Station status 3							
Byte 3	Diag. Master Add							
Byte 4,5	Ident Number							
Byte 6	Diag. Header : 07h							
Byte 7	External diagnosis							
	Bit b7 b6 b5 b4 b3 b2 b1 b0 <table border="1" style="margin-left: 20px;"> <tr> <td>R</td><td>R</td><td>R</td><td>*</td><td>*</td><td>*</td><td>*</td><td>*</td> </tr> </table> b0 : If Communication port A does not receive data : "1" b1 : If Communication port B does not receive data : "1" b2 : If Communication port C does not receive data : "1" b3 : If Communication port D does not receive data : "1" b4 : If Solenoid valve power supply voltage drops : "1" b5-b7 : Reserved (Always "0")	R	R	R	*	*	*	*
R	R	R	*	*	*	*	*	
Byte 8-12	Reserved (Allways "0")							

●Layout of the GW unit Parameter

	Description									
Byte 0	Station status									
Byte 1	WD_Fact_1									
Byte 2	WD_Fact_2									
Byte 3	MinTSDR									
Byte 4,5	Ident_Number									
Byte 6	Group_Ident									
Byte 7-9	Reserved (all 00h)									
Byte 10	Diagnosis function used / Unused									
	<table border="1" style="margin-left: 20px;"> <tr> <td>Bit7</td><td>b7</td><td>b6</td><td>b5</td><td>b4</td><td>b3</td><td>b2</td><td>b1</td><td>b0</td><td>Bit0</td> </tr> </table> b0 : Port A mounting function used "1", unused "0". b1 : Port B mounting function used "1", unused "0". b2 : Port C mounting function used "1", unused "0". b3 : Port D mounting function used "1", unused "0". b4 : Power supply voltage monitor function for solenoid valve used "1", un-used "0" b5-b7 : Reserved (all "0")	Bit7	b7	b6	b5	b4	b3	b2	b1	b0
Bit7	b7	b6	b5	b4	b3	b2	b1	b0	Bit0	
Byte 11	Reserved "00h"									

Display

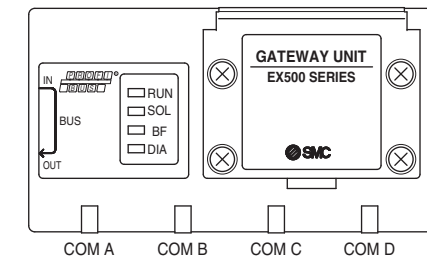

Display	Description
RUN	Lights on: Power for Input and controlling GW/SI is supplied. Lights off: Power for Input and controlling GW/SI is not supplied.
SOL	Lights on: Power is supplied to solenoid valves/output at specified voltage. Lights off: Power is not supplied to solenoid valves/output at specified voltage.(Voltage dropped to lower than 20V)
BF	Lights on: PROFIBUS-DP communication is abnormal. Lights off: PROFIBUS-DP communication is normal.
DIA	Lights on: DIA is abnormal. Lights off: DIA is normal.
COM A	Lights on: COM A is receiving data. Lights off: COM A has no received data.
COM B	Lights on: COM B is receiving data. Lights off: COM B has no received data.
COM C	Lights on: COM C is receiving data. Lights off: COM C has no received data.
COM D	Lights on: COM D is receiving data. Lights off: COM D has no received data.

NOTE

When connecting only manifold valve but not input unit manifold, or connecting nothing to the communication port, LED's on COM A to D do not light up. (diagnosis function of the communication port will work). If the LED's need to light up, (when the diagnosis function should not be operated), connect a terminal plug to the unused connector of the GW and SI unit

Contact

AUSTRIA	(43) 2262 62280	NETHERLANDS	(31) 20 531 8888
BELGIUM	(32) 3 355 1464	NORWAY	(47) 67 12 90 20
CZECH REP.	(420) 541 424 611	POLAND	(48) 22 211 9600
DENMARK	(45) 7025 2900	PORTUGAL	(351) 21 471 1880
FINLAND	(358) 207 513513	SLOVAKIA	(421) 2 444 56725
FRANCE	(33) 1 6476 1000	SLOVENIA	(386) 73 885 412
GERMANY	(49) 6103 4020	SPAIN	(34) 945 184 100
GREECE	(30) 210 271 7265	SWEDEN	(46) 8 603 1200
HUNGARY	(36) 23 511 390	SWITZERLAND	(41) 52 396 3131
IRELAND	(353) 1 403 9000	UNITED KINGDOM	(44) 1908 563888
ITALY	(39) 02 92711		

SMC Corporation

URL <http://www.smcworld.com> (Global) <http://www.smceu.com> (Europe)

Specifications are subject to change without prior notice from the manufacturer.
© SMC Corporation All Rights Reserved.