



## Installation and Maintenance Manual

### Electric Actuator / Slider Type

#### Series LEF

Applicable model number:

LEFS\*AA-\*

LEFS\*AB-\*

LEFB\*AT-\*



## 1 Safety Instructions

This manual contains essential information for the protection of users and others from possible injury and/or equipment damage.

- Read this manual before using the product to ensure correct handling and also read the manuals of related apparatus before use.
- Keep this manual in a safe place for future reference.
- These instructions indicate the level of potential hazard by label of "Caution", "Warning" or "Danger", followed by important safety information which must be carefully followed.
- To ensure safety of personnel and equipment the safety instructions in this manual and the product catalogue must be observed, along with other relevant safety practices.

<b>Caution</b>	Indicates a hazard with a low level of risk. Which if not avoided, could result in minor or moderate injury.
<b>Warning</b>	Indicates a hazard with a medium level of risk. Which if not avoided, could result in death or serious injury.
<b>Danger</b>	Indicates a hazard with a high level of risk. Which if not avoided, will result in death or serious injury.

- Electromagnetic compatibility: This product is class A equipment that is intended for use in an industrial environment. There may be potential difficulties in ensuring electromagnetic compatibility in other environments due to conducted as well as radiated disturbances.

### Warning

- **Do not disassemble, modify (including change of printed circuit board) or repair the product.**  
An injury or product failure may result.
- **Do not operate the product beyond the specification range.**  
Fire, malfunction or equipment damage may result.  
Use the product only after confirming the specifications.
- **Do not use the product in the presence of flammable, explosive or corrosive gas.**  
Fire, explosion or corrosion may result.  
This product does not have an explosion proof construction.
- **When using the product as part of an interlocking system:**  
Provide a double interlocking system, for example a mechanical system. Check the product regularly to ensure correct operation.
- **Before performing maintenance, be sure of the following:**  
Turn off the power supply.

### Caution

- **Always perform a system check after maintenance.**  
Do not use the product if any error occurs.  
Safety cannot be assured if caused by un-intentional malfunction.
- **Provide grounding to ensure correct operation and to improve noise resistance of the product.**  
This product should be individually grounded using a short cable.
- **Follow the instructions given below when handling the product.**  
Failing to do so may result in product damage.
- **Maintenance space should always be provided around the product.**
- **Do not remove labels from the product.**
- **Do not drop, hit or apply excessive shock to the product.**
- **Unless stated otherwise, follow all specified tightening torques.**
- **Do not bend, apply tensile force, or apply force by placing heavy loads on the cables.**

## 1 Safety Instructions (continued)

- **Connect wires and cables correctly and do not connect while the power is turned on.**
- **Do not route input/output wires and cables together with power or high-voltage cables.**
- **Check the insulation of wires and cables.**
- **Take appropriate measures against noise, such as noise filters, when the product is incorporated into other equipment or devices.**
- **Take sufficient shielding measures when the product is to be used in the following conditions:**
  - Where noise due to static electricity is generated.
  - Where electro-magnetic field strength is high.
  - Where radioactivity is present.
  - Where power lines are located.
- **Do not use the product in a place where electrical surges are generated.**
- **Use suitable surge protection when a surge generating load such as a solenoid valve is to be directly driven.**
- **Prevent any foreign matter from entering this product.**
- **Do not expose the product to vibration or impact.**
- **Use the product within the specified ambient temperature range.**
- **Do not expose the product to any heat radiation.**
- **Use a precision screwdriver with flat blade to adjust the DIP switch.**
- **Close the cover over the switches before power is turned on.**
- **Do not clean the product with chemicals such as benzene or thinners.**

## 2 General Instructions

### 2.1 Wiring

#### Warning

- **Adjusting, mounting or wiring change should not be done before disconnecting the power supply to the product.**  
Electrical shock, malfunction and damage can result.
- **Do not disassemble the cables.**
- **Use only specified cables.**

- **Do not connect or disconnect the wires, cables and connectors when the power is turned on.**

#### Caution

- **Wire the connector correctly and securely.**  
Check the connector for polarity and do not apply any voltage to the terminals other than those specified in the Operation Manual.
- **Take appropriate measures against noise.**  
Noise in a signal line may cause malfunction. As a countermeasure separate the high voltage and low voltage cables, and shorten the wiring lengths, etc.
- **Do not route input/output wires and cables together with power or high voltage cables.**  
The product can malfunction due to interference of noise and surge voltage from power and high voltage cables to the signal line. Route the wires of the product separately from power or high voltage cables.
- **Take care that actuator movement does not catch cables.**
- **Operate with all wires and cables secured.**
- **Avoid bending cables at sharp angles where they enter the product.**
- **Avoid twisting, folding, rotating or applying an external force to the cable.**  
Risk of electric shock, wire breakage, contact failure and loss of control of the product can happen.
- **Fix the motor cables protruding from the actuator in place before use.**  
The motor and lock cables are not robotic type cables and can be damaged when moved.
- **The actuator cables connecting the actuator and the controller are robotic type cables. But should not be placed in a flexible moving tube with a radius smaller than the specified value. (Min. 50 mm)**

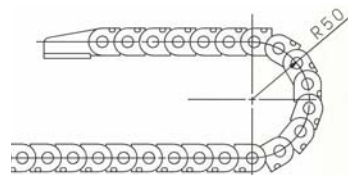

## 2 General Instructions (continued)

- **Confirm correct insulation of the product.**  
Poor insulation of wires, cables, connectors, terminals etc. can cause interference with other circuits. Also there is the possibility that excessive voltage or current may be applied to the product causing damage.

### 2.2 Transportation

#### Caution

- **Do not carry or swing the product by the cables.**

### 2.3 Mounting

#### Warning

- **Observe the tightening torque for screws.**  
Unless stated otherwise, tighten the screws to the recommended torque for mounting the product.
- **Do not make any alterations to this product.**  
Alterations made to this product may lead to a loss of durability and damage to the product, which can lead to human injury and damage to other equipment and machinery.
- **When an external guide is used, connect the moving parts of the product and the load in such a way that there is no interference at any point within the stroke.**  
Do not scratch or dent the sliding parts of the table or mounting face etc., by striking or holding them with other objects. The components are manufactured to precise tolerances, so that even a slight deformation may cause faulty operation or seizure.
- **Do not use the product until you verify that the equipment can be operated correctly.**  
After mounting or repair, connect the power supply to the product and perform appropriate functional inspections to check it is mounted correctly.
- **When attaching to the work piece, do not apply strong impact or large moment.**  
If an external force over the allowable moment is applied, it may cause looseness in the guide unit, an increase in sliding resistance or other problems.

- **Maintenance space**  
Allow sufficient space for maintenance and inspection.

### 2.4 Handling

#### Warning

- **Do not touch the motor while in operation.**  
The surface temperature of the motor can increase to approx. 90°C to 100°C due to operating conditions.  
Energizing alone may also cause this temperature increase.  
As it may cause burns, do not touch the motor when in operation.
- **If abnormal heating, smoking or fire, etc. occurs in the product, immediately turn off the power supply.**
- **Immediately stop operation if abnormal operation noise or vibration occurs.**  
If abnormal operation noise or vibration occurs, the product may have been mounted incorrectly. Unless operation of the product is stopped for inspection, the product can be seriously damaged.
- **Never touch the rotating part of the motor or the moving part of the actuator while in operation.**  
There is a serious risk of injury.
- **When installing, adjusting, inspecting or performing maintenance on the product, controller and related equipment, be sure to turn off the power supply to each of them. Then, lock it so that no one other than the person working can turn the power on, or implement measures such as a safety plug.**
- **In the case of the actuator that has a servo motor (24VDC), the "motor phase detection step" is done by inputting the servo on signal just after the controller power is turned on.**  
The "motor phase detection step" operates the table/rod to the maximum distance of the lead screw. (The motor rotates in the reverse direction if the table hits an obstacle such as the end stop damper.) Take the "motor phase detection step" into consideration for the installation and operation of this actuator

## 2 General Instructions (continued)

#### Caution

- **Keep the controller and product combined as delivered for use.**  
The product is set in parameters for shipment.  
If it is combined with a different product parameter, failure can result.
- **Check the product for the following points before operation.**
  - Damage to electric driving line and signal lines.
  - Looseness of the connector to each power line and signal line.
  - Looseness of the actuator/cylinder and controller/driver mounting.
  - Abnormal operation.
  - Stop function
- **When more than one person is performing work, decide on the procedures, signals, measures and resolution for abnormal conditions before beginning the work.**
- **Also designate a person to supervise the work, other than those performing the work.**
- **An operation test should be performed at low speed, start the test at a predefined speed, after confirming there are no problems.**
- **Actual speed of the product will be changed by the workload.**  
Before selecting a product, check the catalogue for the instructions regarding selection and specifications.
- **Do not apply a load, impact or resistance in addition to a transferred load during return to origin.**  
In the case of the return to origin by pushing force, additional force will cause displacement of the origin position since it is based on detected motor torque.
- **Do not remove the nameplate.**

### 2.5 Actuator with lock

#### Warning

- **Do not use the lock as a safety lock or a control that requires a locking force.**  
The lock used for the product with a lock is designed to prevent dropping of work piece.

- **For vertical mounting, use the product with a lock.**  
If the product is not equipped with a lock, the product will move and drop the work piece when the power is removed.
- **"Measures against drops" means preventing a work piece from dropping due to its weight when the product operation is stopped and the power supply is turned off.**
- **Do not apply an impact load or strong vibration while the lock is activated.**  
If an external impact load or strong vibration is applied to the product, the lock will lose its holding force and damage to the sliding part of the lock or reduced lifetime can result. The same situation will happen when the lock slips due to a force higher than its holding force, as this will accelerate the wear to the lock.
- **Do not apply liquid, oil or grease to the lock or its surroundings.**  
When liquid, oil or grease is applied to the sliding part of the lock, its holding force will be reduced significantly.
- **Take "measures against drops" and check that safety is assured before mounting, adjustment and inspection of the product.**  
If the lock is released with the product mounted vertically, a work piece can drop due to its weight.

2.6 Please refer to the auto switch references in "Best Pneumatics " when an auto switch is to be used.

### 2.7 Unpacking

#### Caution

- **Check the received product is as ordered.**  
If a different product is installed from the one ordered, injury or damage could result.

### 3 Specifications

#### LEFS series - Ball screw drive

Model		LEFS 16A		LEFS 25A	
Stroke (mm)		See the "Weight" table below for the applicable strokes.			
Work load (kg) <sup>Note2)</sup>	Horizontal	7	10	11	18
	Vertical	2	4	2.5	5
Speed (mm/s) <sup>Note2)</sup>		10 - 500	5 - 250	12 - 500	6 - 250
Positioning repeatability (mm)		± 0.02			
Lead (mm)		10	5	12	6
Impact resistance/vibration resistance (m/s <sup>2</sup> ) <sup>Note3)</sup>		50 / 20			
Drive method		Ball screw			
Guide type		Linear guide			
Operating temperature range (°C)		5 to 40 (No condensation or freezing)			
Operating humidity range (%)		35 to 85 (No condensation or freezing)			
Motor size		□28		□42	
Type of Motor		Servo motor (24VDC)			
Encoder		Incremental A/B phase (800 pulse/rotation)/Z phase			
Rated voltage (VDC)		24 ±10%			
Power consumption (W) <sup>Note4)</sup>		63		102	
Standby power consumption when operating (W) <sup>Note5)</sup>		Horizontal : 4 Vertical : 9		Horizontal : 4 Vertical : 9	
Momentary max. power consumption (W) <sup>Note6)</sup>		70		113	
Controller weight (kg)		0.15 (Screw mounting type), 0.17 (DIN rail mounting type)			
Type <sup>Note7)</sup>		No excitation operating type			
Holding force (N)		20	39	78	157
Power consumption (W) <sup>Note8)</sup>		3.6		5	
Rated voltage (VDC)		24 ±10%			

#### Weight

Model	LEFS16A				LEFS25A					
Stroke (mm) <sup>Note1)</sup>	100	200	300	(400)	100	200	300	(400)	500	(600)
Weight (kg)	0.90	1.05	1.20	1.35	1.84	2.12	2.40	2.68	2.96	3.24
Additional weight for lock (kg)	0.12				0.19					

Note 1) The strokes shown in ( ) are produced upon receipt of order.

Note 2) The speed is dependent on the workload. Check the "Speed-workload graphs" for the selected model in the catalogue or the operation manual.

Note 3) Impact resistance:

No malfunction occurred when the actuator was tested with a drop tester in both an axial direction and perpendicular direction to the lead screw. (The test was performed with the actuator in the initial state.)

Vibration resistance:

No malfunction occurred in a test ranging between 45 to 2000 Hz, when the actuator was tested in both an axial direction and a perpendicular direction to the lead screw. (The test was performed with the actuator in the initial state.)

Note 4) The "Power consumption" (including the controller) is for when the actuator is operating.

Note 5) The "Standby power consumption when operating" (including the controller) is for when the actuator is stopped in the set position during operation with the maximum workload.

Note 6) The "Momentary max. power consumption" (including the controller) is for when the actuator is operating.

This value can be used for the selection of the power supply.

Note 7) Only applies to actuators supplied with a lock.

Note 8) For the actuator with lock, please add the power consumption for the lock.

#### LEFB series - Belt drive

Model		LEFB 16A		LEFB 25A	
Stroke (mm)		See the "Weight" table below for the applicable strokes.			
Work load (kg) <sup>Note2)</sup>	Horizontal	1		2	
	Vertical	48 - 2000		48 - 2000	
Speed (mm/s) <sup>Note2)</sup>		48 - 2000			
Positioning repeatability (mm)		± 0.1			
Lead equivalent (mm)		48		48	
Impact resistance/vibration resistance (m/s <sup>2</sup> ) <sup>Note3)</sup>		50 / 20			
Drive method		Belt			
Guide type		Linear guide			
Operating temperature range (°C)		5 to 40 (No condensation or freezing)			
Operating humidity range (%)		35 to 85 (No condensation or freezing)			
Motor size		□28		□42	
Type of Motor		Servo motor (24VDC)			
Encoder		Incremental A/B phase (800 pulse/rotation)/Z phase			
Rated voltage (VDC)		24 ±10%			
Power consumption (W) <sup>Note4)</sup>		78		69	
Standby power consumption when operating (W) <sup>Note5)</sup>		4		5	
Momentary max. power consumption (W) <sup>Note6)</sup>		87		120	
Controller weight (kg)		0.15 (Screw mounting type), 0.17 (DIN rail mounting type)			
Type <sup>Note7)</sup>		No excitation operating type			
Holding force (N)		4		19	
Power consumption (W) <sup>Note8)</sup>		3.6		5	
Rated voltage (VDC)		24 ±10%			

### 3 Specification (continued)

#### Weight

Model	LEFB16A							LEFB25A									
Stroke (mm) <sup>Note1)</sup>	(300)	500	(600)	(700)	800	(900)	1000	(1200)	(1500)	(1800)	(2000)						
Weight (kg)	1.19	1.45	1.58	1.71	1.84	1.97	2.10										
Additional weight for lock (kg)	0.12																
Model	LEFB25A																
Stroke (mm) <sup>Note1)</sup>	(300)	500	(600)	(700)	800	(900)	1000	(1200)	(1500)	(1800)	(2000)						
Weight (kg)	2.39	2.85	3.08	3.31	3.54	3.77	4.00	4.46	5.15	5.84	6.30						
Additional weight for lock (kg)	0.19																

Note 1) The strokes shown in ( ) are produced upon receipt of order.

Note 2) The speed is dependent on the workload.

Check the "Speed-workload graph" for the selected model in the catalogue or operation manual.

Note 3) Impact resistance:

No malfunction occurred in a test ranging between 45 to 2000 Hz, when the actuator was tested in both an axial direction and a perpendicular direction to the lead screw. (The test was performed with the actuator in the initial state.)

Vibration resistance:

No malfunction occurred in a test ranging between 45 to 2000 Hz. Test was performed in both an axial direction and a perpendicular direction to the drive belt. (The test was performed with the actuator in the initial state.)

Note 4) The "Power consumption" (including the controller) is for when the actuator is operating.

Note 5) The "Standby power consumption when operating" (including the controller) is for when the actuator is stopped in the set position during operation with the maximum workload.

Note 6) The "Momentary max. power consumption" (including the controller) is for when the actuator is operating.

This value can be used for the selection of the power supply.

Note 7) Only applies to actuators supplied with a lock.

Note 8) For the actuator with lock, please add the power consumption for the lock.

### 4 Installation

#### 4.1 Design and selection

#### Warning

- Do not apply a load in excess of the actuator specification. A product should be selected based on the maximum work load and allowable moment. If the product is used outside of the operating specification, the eccentric load applied to the guide will become excessive and have adverse effects such as creating play in the guide, reduced accuracy and reduced product life.
- Do not exceed the speed limit of the actuator specification. Select a suitable actuator by the relationship of allowable work load and speed. Noise or reduction of accuracy may occur if the actuator is operated in excess of its specification and could lead to reduced accuracy and reduced product life.
- Do not use the product in applications where excessive external force or impact force is applied to it. This can lead to premature failure of the product.

#### Caution

- Do not operate by fixing the table and moving the actuator body. An excessive load will be applied to the table, which could lead to damage to the actuator and reduced accuracy and reduced product life.
- Belt drive actuator cannot be used for vertically mounted applications.
- In the case of the belt driven actuator, vibration may occur during operation at speeds within the actuator specification, this could be caused by the operating conditions. Change the speed setting to a speed that does not cause vibration.

### 4 Installation (continued)

#### 4.2 Mounting

#### Caution

- Keep the flatness of mounting surface to within 0.1 mm or less. Insufficient flatness of the work piece or the surface onto which the actuator body is to be mounted can cause play in the guide and increased sliding resistance.
- When mounting the workpiece or other device to the actuator tighten the fixing screws with adequate torque within the specified torque range. Tightening the screws with a higher torque than the maximum may cause malfunction, whilst tightening with a lower torque can cause the displacement of the mounting position or in extreme conditions detaching of the work piece.

#### Work piece mounting

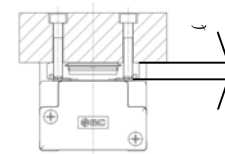

Model	Bolt size	Maximum tightening torque (N·m)	ℓ (Maximum thread depth (mm))
LEF*16A	M4 x 0.7	2.1	6
LEF*25A	M5 x 0.8	5.7	8

Use screws with adequate length, but with length less than the maximum thread depth.

The use of screws that are too long can touch the body and cause malfunction.

- When mounting the actuator, use screws with adequate length and tighten them with adequate torque and use all of the mounting holes to maintain the catalogue performance.

Tightening the screws with a higher torque than recommended may cause malfunction, whilst the tightening with lower torque can cause the displacement of mounting position or in extreme conditions the actuator could become detached from its mounting position.

#### Actuator mounting

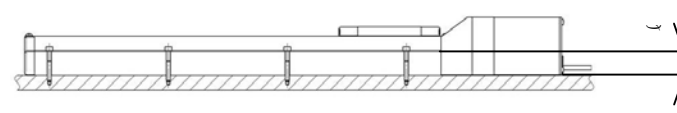

Model	Bolt size	φA (mm)	ℓ (mm)
LEF*16A	M3	3.4	20
LEF*25A	M4	4.3	24

- When mounting the actuator, leave a gap of 40mm or more to allow for bending of the actuator cable.

### 5 Names and Functions of Individual Parts

#### LEFS series – Ball screw drive

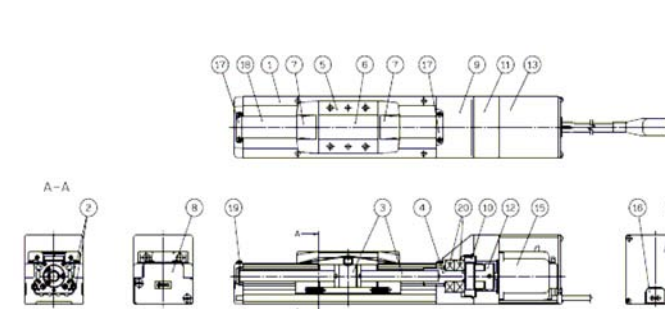

(See LEFS parts list in next column)

### 5 Names and Functions of Individual Parts (continued)

#### Parts list for LEFS

No.	Part	Material	Remarks
1	Body	Aluminium alloy	Anodized
2	Rail guide	-	
3	Ball screw Ass'y	-	
4	Connector shaft	Stainless steel	
5	Table	Aluminium alloy	Anodized
6	Blanking plate	Aluminium alloy	Anodized
7	Seal band holder	Synthetic resin	
8	Housing A	Aluminium die-cast	Chromating
9	Housing B	Aluminium alloy	Anodized
10	Bearing holder	Aluminium alloy	
11	Motor mount	Aluminium alloy	Anodized
12	Coupling	-	
13	Motor cover	Aluminium alloy	Anodized
14	End cover	Aluminium alloy	Anodized
15	Motor	-	
16	Rubber bushing	NBR	
17	Band holder	Stainless steel	
18	Dust seal band	Stainless steel	
19	Bearing	-	
20	Bearing	-	

#### LEFB series – Belt drive

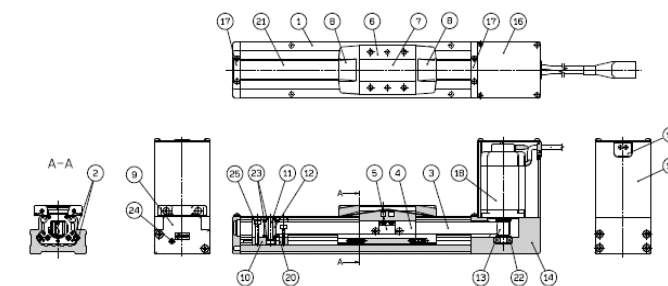

#### Parts list for LEFB

No.	Part	Material	Remarks
1	Body	Aluminium alloy	Anodized
2	Rail guide	-	
3	Belt	-	
4	Belt holder A	Carbon steel	Chromating
5	Belt holder B	Aluminium alloy	Anodized
6	Table	Aluminium alloy	Anodized
7	Blanking plate	Aluminium alloy	Anodized
8	Seal band holder	Synthetic resin	
9	Housing A	Aluminium die-cast	Chromating
10	Pulley holder	Aluminium alloy	
11	Pulley shaft	Stainless steel	
12	End pulley	Aluminium alloy	Anodized
13	Motor pulley	Aluminium alloy	Anodized
14	Motor mount	Aluminium alloy	Anodized
15	Motor cover	Aluminium alloy	Anodized
16	End cover	Aluminium alloy	Anodized
17	Band holder	Stainless steel	
18	Motor	-	
19	Rubber bushing	NBR	
20	Stopper	Aluminium alloy	
21	Dust seal band	Stainless steel	
22	Bearing	-	
23	Bearing	-	
24	Tension adjustment bolt	Chromium molybdenum steel	Nickel plating
25	Pulley holding bolt	Chromium molybdenum steel	Nickel plating

## 6 Wiring

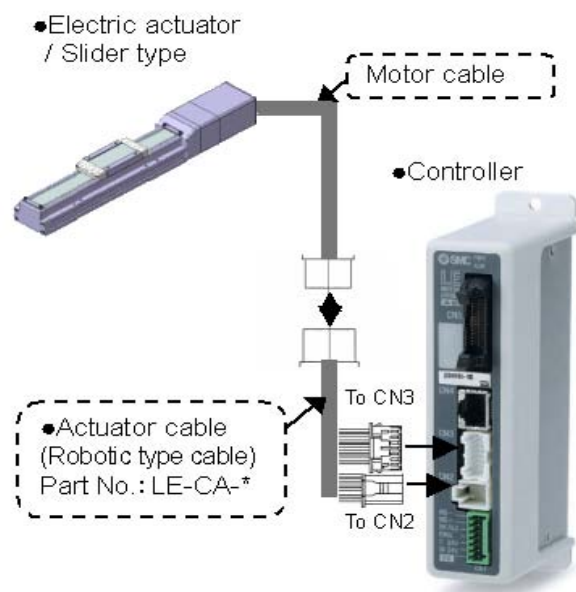

### Warning

Use only specified cables otherwise there may be risk of fire and damage.

## 7 Maintenance

### Warning

- **Do not disassemble or repair the product.**  
Fire or electric shock can result.
- **Before modifying or checking the wiring, the voltage should be checked with a tester 5 minutes after the power supply is turned off.**  
Electrical shock can result.

### Caution

- **Maintenance should be performed according to the procedure indicated in the Operating Manual.**  
Incorrect handling can cause an injury, damage or malfunction of equipment and machinery.
- **Removal of product.**  
When equipment is serviced, first confirm that measures are in place to prevent dropping of work pieces and run-away of equipment, etc. and then turn off the power supply to the system.  
When the machinery is restarted, check that the operation is normal with the actuator in a safe position.
- **The product has been lubricated for life at manufacturer, and does not require lubrication in service.**  
When lubrication is applied, special grease must be used.  
Please read the maintenance manual for each actuator.
- **Maintenance frequency.**  
Perform maintenance according to the table below.  
Contact SMC if any abnormality is found.

Frequency	Appearance check	Internal check	Belt check
Inspection before daily operation	○	○	○
Inspection every 6 months / 1000 km / 5 million cycles *	○	○	○

\* Whichever occurs first

## 7 Maintenance (continued)

- **Items for visual appearance check.**  
Loose screws, abnormal dirt.  
Check of flaws/faults and cable connections.  
Vibration, noise.
- **Items for internal check**  
Lubricant condition on moving parts.  
Loose or mechanical play in fixed parts or fixing screws.
- **Items for belt check**  
Check the belt regularly as shown in "maintenance frequency".  
Stop operation immediately and contact SMC when the belt appears to be like the photographs shown below.

- **Tooth shape canvas is worn out**  
Canvas fibre becomes fuzzy.  
Rubber is removed and the fibre becomes whitish.  
Lines of fibres become unclear.



Teeth become fuzzy

- **Peeling off or wearing of the side of the belt**  
Belt corner becomes round and frayed threads stick out.



- **Belt partially cut**  
Belt is partially cut.  
Foreign matter caught in teeth other than cut part causes flaw.
- **Vertical line of belt teeth**  
Flaw, which is made when the belt runs on the flange.
- **Rubber back of the belt is softened and sticky.**
- **Crack on the back of the belt.**



- **How to detach and attach the dust seal band**  
For the purpose of internally checking the actuator as recommended in the maintenance frequency schedule, the method of detaching and attaching the dust seal band is shown as the follows.

### Dis-assembly

1. **Loosen the fixing bolts of end side of the "Band holder".**  
(The picture shows LEFB, but LEFS is same instruction as LEFB.)  
Pay attention to not cut hand on the edges of the "Dust seal band".  
Note: The "Dust seal band" can only be removed by loosening the "Band holder" bolts.

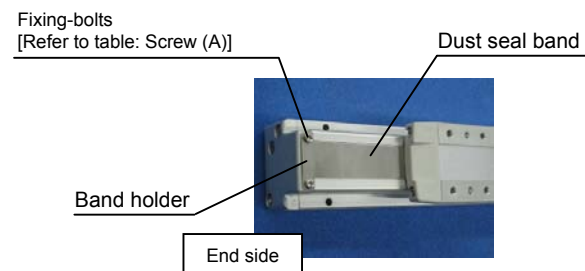

2. **Remove the "Seal band holder" and the "plate" as shown.**

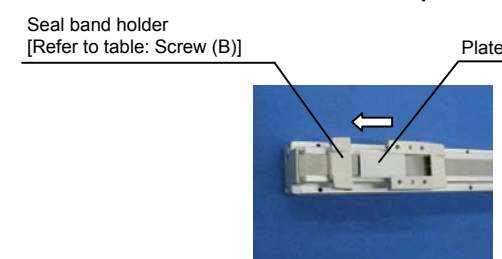

## 7 Maintenance (continued)

3. **Loosen the fixing bolts of motor side of the "Band holder" and then remove the "Dust seal band".**

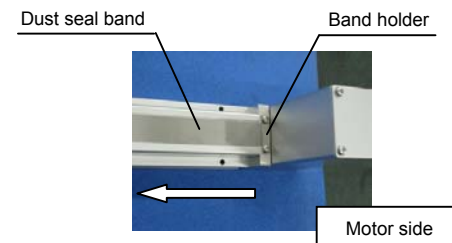

### Re-assembly

The re-assembly is completed by the reverse procedure of "Dis-assembly" sections 1, 2 and 3.

Screw (A)		
Model	Type of bolt	Bolt size
LEFB16A	Round head combination screw	M2.5 x 5
LEFB25A	Round head combination screw	M3 x 6

Screw (B)		
Model	Type of bolt	Bolt size
LEFB16A	Cross recessed round head screw	M2.5 x 5
LEFB25A	Cross recessed round head screw	M3 x 6

## 8 CE Directive

The LE series of actuators and motor controllers conform to the EU EMC directive, if they are installed in accordance with the following instructions.

These components are intended for incorporation into machinery and assemblies forming part of a larger system.

The CE compliance was achieved when the above two components were connected as shown in the diagram below.

Please note that the EMC changes according to the configuration of the customers control panel and the relationship with other electrical equipment and wiring. Therefore conformity to the EMC directive cannot be certified for SMC components incorporated into the customer's equipment under actual operating conditions. As a result it is necessary for the customer to verify conformity to the EMC directive for the machinery and equipment as a whole.

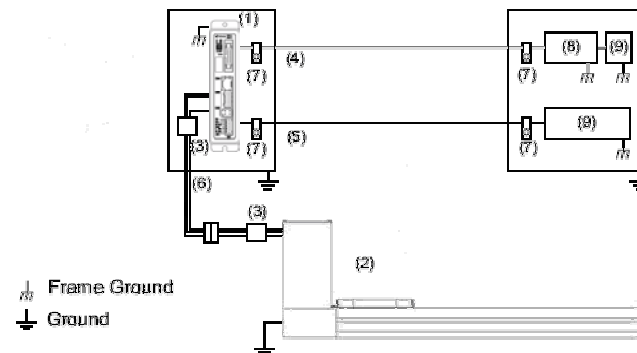

### Machinery parts list

No.	Part name	Part no./Material
1	Motor controller	LECA6 Series
2	Actuator	LE Series
3	Noise Filter	LEC-NFA (74271222[WURTH ELEKTRONIK])
4	I/O cable (with shield)	LEC-CN5-□
5	Power supply cable (with shield)	5 wire with shield (3m)
6	Actuator cable	LE-CA-□
7	P-clip (for shield ground)	metal
8	Programmable controller	-
9	Switching power supply	-

Please refer to the IMM of the LEC being used for information on the LEC installation procedure.

## 8 CE Directive (continued)

### Grounding the Actuator

Actuator must be grounded to shield the actuator from electric noise, as shown below. The bolt and cable with crimping terminal should be prepared separately.

### Location of grounding point

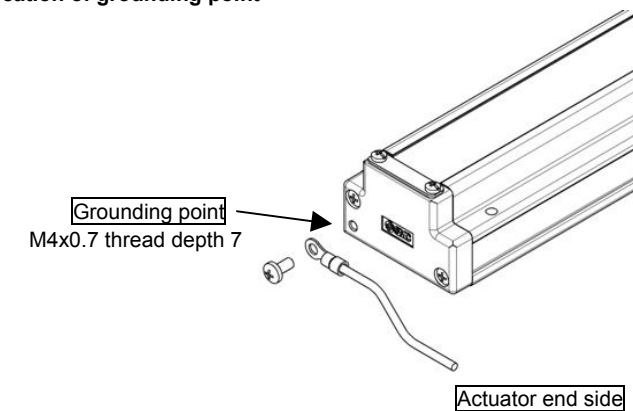

### Caution

The product should be connected to a ground. The cross-sectional area of this wire shall be a minimum of 2 mm<sup>2</sup>. The grounding point should be as near as possible to the actuator to keep the wire length short.

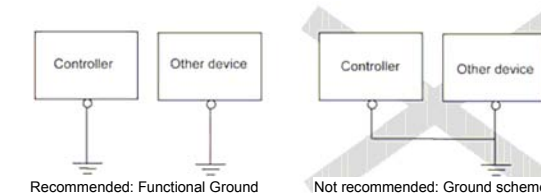

- **Grounding the controller**  
Please refer to the IMM of the LEC being used, for information on grounding the controller.

## 9 Contacts

AUSTRIA	(43) 2262 62280	NETHERLANDS	(31) 20 531 8888
BELGIUM	(32) 3 355 1464	NORWAY	(47) 67 12 90 20
CZECH REP.	(420) 541 424 611	POLAND	(48) 22 211 9600
DENMARK	(45) 7025 2900	PORTUGAL	(351) 21 471 1880
FINLAND	(358) 207 513513	SLOVAKIA	(421) 2 444 56725
FRANCE	(33) 1 6476 1000	SLOVENIA	(386) 73 885 412
GERMANY	(49) 6103 4020	SPAIN	(34) 945 184 100
GREECE	(30) 210 271 7265	SWEDEN	(46) 8 603 1200
HUNGARY	(36) 23 511 390	SWITZERLAND	(41) 52 396 3131
IRELAND	(353) 1 403 9000	UNITED KINGDOM	(44) 1908 563888
ITALY	(39) 02 92711		

## SMC Corporation

URL : <http://www.smcworld.com> (Global) <http://www.smceu.com> (Europe)

Specifications are subject to change without prior notice from the manufacturer.

© 2009 SMC Corporation All Rights Reserved.