



# Installation and Maintenance Manual

## LXP Series Low Profile Electric Actuator

For future reference, please keep this manual in a safe place

This manual should be read in conjunction with the current product catalogue

### Safety Instructions

These safety instructions are intended to prevent a hazardous situation and/or equipment damage. These instructions indicate the level of potential hazard by a label of "Caution", "Warning" or "Danger". To ensure safety, be sure to observe ISO10218 (Note 1), JIS 8433 (Note 2) and other safety practices.

**CAUTION** : Operator error could result in injury or equipment damage.

**WARNING**: Operator error could result in serious injury or loss of life.

**DANGER** : In extreme conditions, there is a possible result of serious injury or loss of life.

Note 1: ISO 10218: Manipulating industrial robots - Safety.  
Note 2: JIS 8433: Robot safety axiom.

### WARNING

#### 1. The compatibility of electric actuators is the responsibility of the person who designs the system or decides its specifications.

Since the products specified here are used in various operating conditions, their compatibility for the specific system must be based on specifications or after analysis and/or tests to meet your specific requirements.



Fig 1

### General

#### CAUTION

- Ensure all air and power supplies are ISOLATED before transportation, installation, wiring, and maintenance, it may cause electric shock.
- Do not install this actuator in flammable, explosive, or corrosive atmosphere.
- Wiring must NOT be damaged, receive any stress, be subjected to heavy loads or be sandwiched, it may cause electric shock.

#### CAUTION

- Operating manual should be carefully read to understand and follow instructions before installation, operation, maintenance, otherwise it may cause electric shock or fire.
- Do not use damaged actuator nor driver. Failure, fire etc may result.
- Motor and driver should be used in the designated combination. Otherwise it may cause fire and malfunction.

### Transportation

- Do not take the cable during the transportation. Malfunction and failure may result.

### Stock

- Do not keep in stock in environment where exposed to rain, dewing, harmful gas or liquid, sunshine.
- Keep in stock in the designated temperature and humidity (-20°C -70°C, 10-90% without dewing).

### Unpacking

#### CAUTION

Confirm if product is according to your order. In case of installing wrong product, failure and malfunction may occur.

### 2. Only trained personnel should operate this equipment.

Electric actuators can be dangerous if an operator is unfamiliar with them. Assembly, handling or repair of systems using electric actuators should be performed by trained and experienced operators.

### 3. Do not service machinery/equipment or attempt to remove components until safety is confirmed.

- Inspection and maintenance of machinery/equipment should only be performed after confirmation of safe locked-out control positions.
- When equipment is to be removed, confirm the safety process as mentioned above, and shut off the power supply for this equipment.
- Before machinery/equipment is restarted, confirm that safety measures are in effect.

### 4. Contact SMC if the product is to be used in any of the following conditions:

- Conditions and environments beyond the given specifications, or if product is used outdoors
- Installation on equipment in conjunction with atomic energy, medical equipment, food and beverages, or safety equipment.
- An application which has the possibility of having negative effects on people, property, or animals, requiring special safety analysis.

### Wiring

#### CAUTION

- Use this product under category 1 of excess voltage specified by IEC664.  
Use double isolated power source.
- Wiring and checking should be done after 1 minute later of power off. Otherwise electrical shock may result.
- Connection with power source cable should be completed according to connection drawing or operation manual. Electrical shock or fire may occur.
- Use surely release switch as an emergency stop switch.

#### CAUTION

- Do not measure isolation resistance isolation withstand pressure. Failure may result.
- Measures against noise should be taken as follows;  
Remove the power source noise by putting line filter on power line. Separate power cables or motor cable from signal wires.
- Take ground by using PE terminal equipped table and body of actuator.

### Operation

#### WARNING

- Establish external emergency stop circuit in case operation immediately stops and power should be switched off.
- Release emergency stop after the confirming no control signals.
- Over load, mis-setting of speed or acceleration causes power swing. In this case operating part may work unexpected.

### Specifications

Model	LXPB25A	LXPB25B	LXPB55A	LXPB55B
Stroke (mm)		50, 75, 100, 125, 150, 175, 200		
Motor	2-phase stepping motor		5-phase stepping motor	
Screw (mm)	ø8, Lead 6	ø8, Lead 12	ø8, Lead 6	ø8, Lead 12
Max. pay load (horizontal)	6kg	3kg	4kg	2kg
Max. pay load (vertical)	5kg	3kg	4kg	2kg
Max. speed	100mm/s	200mm/s	100mm/s	200mm/s
Positioning repeatability	±0.05mm			
Type of guide	Linear ball bearing			
Operating temperature range	5 to 40°C (no dewing)			

### Brake specifications

Model	Negative actuate type
Static torque	0.1Nm (1kgf-cm) or more
Rated voltage	24V (DC)±5%
Power consumption	5W (at 75°C)

### Installation

#### WARNING

- Ensure all power supplies are ISOLATED before commencing installation.
- DO NOT install this actuator in an explosive atmosphere.
- Protect the actuator from oil/water splashes and excessive dust.
- DO NOT use in a welding environment (Contact SMC).
- DO NOT subject the actuator to excessive vibration or impact shock.
- Stepping motor must be operated at less than 50% of duty ratio independent of load value.
- The actuator may be mounted horizontally or vertically.

### In case of LXS/LXP

- Brake function is not to keep the position of load secure. When it is used for safety brake, take further safety measures. Otherwise machine (or facilities) may be broken.
- Electric brake is off brake designed for emergency only. When it is always used, brake function is spoiled for a short period and it cannot be released. In addition, when it is further used, brake should be burned and has no control function. Actuator may operate recklessly and may be injured.

#### CAUTION

- Do not make extremely adjusting modification. It may cause unstable operation.
- Do not close to the machine after just recovery of power failure. Actuator may suddenly operate. (Design the machine to keep the safety against operator even if re-operation of actuator.)
- Confirm correct power specifications. Malfunction may occur.
- Confirm turning direction before connection with another machine. Failure of machine may occur.
- Make it operate after the confirmation of setting for actuator and driver. Fire may occur.

### Maintenance

#### DANGER

Wiring and maintenance should be done after 1 minute of power off and confirming voltage by tester.

#### CAUTION

- Pay attention to high temperature radiator of driver and motor in case of maintenance. Burn may result.
- Condenser on power line will decrease its capacity due to degradation. We recommend to replace every 10 years to avoid secondary disaster.

### 2. Through-hole

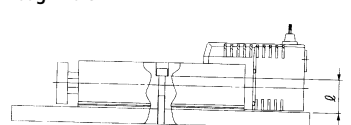

Series	Bolt	Max. tightening torque Nm (kgf-cm)	Body thickness (mm)
LXP	M5x0.8	4.4 (44.9)	37.5

Fig 2b

### 3. T-slot

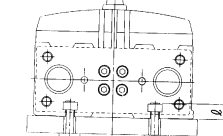

Series	Bolt	Max. tightening torque Nm (kgf-cm)	Max. tightening depth (mm)
LXP	M5x0.8	7.4 (75.5)	8.5

Mounting bolts should be at least 0.5mm shorter than the maximum tightening depth to prevent the bolt from contacting the body.

Fig 2c

### Work mounting (Fig 3)

#### How to mount work

#### 1. Front mounting

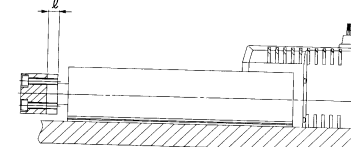

Series	Bolt	Max. tightening torque Nm (kgf-cm)	Max. tightening depth (mm)
LXP	M6x1	7.4 (75.5)	10

Fig 3

### Construction (Fig 5)

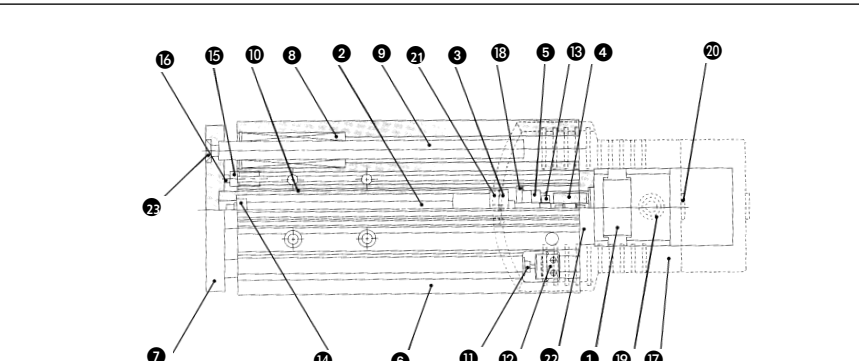

No.	Description	Material	Note
1	Motor	-	Stepping motor
2	Forged screw	Alloy steel	
3	Nut	Resin	
4	Coupling	-	Chromated
5	Bearing	-	Nickel plated
6	Body	Aluminium alloy	
7	Mounting plate	Soft steel	Chromated
8	Linear ball bearing	-	Anodised
9	Guide rod	Bearing steel	
10	Tube	Aluminium alloy	
11	Sensor pin	Stainless steel	
12	Photo micro sensor	-	
13	Lock nut	Carbon steel	Black zinc chromated
14	Stopper nut	Aluminium alloy	
15	Damper bolt	Bearing steel	Nickel plated
16	Damper	Resin	
17	Motor cover	Resin	
18	Tension ring	Stainless steel	
19	Cable cap	-	
20	Plug	-	
21	Magnet	-	
22	Adapter	Aluminium alloy	
23	Plate mounting bolt	Carbon steel	Nickel plated

Fig 5

### Brake Precautions

#### CAUTION

- DO NOT use in inflammable or explosive atmosphere. Slippage during braking may generate sparks.
- The brake has been designed for "Holding" and emergency stopping only. If repeatedly used for braking, performance will deteriorate rapidly.

#### Prior to mounting the brake

- Ensure the correct size wire is used according to the power supply capacity.
- Commence operation ONLY after confirming correct electrical brake wiring. See fig 31.  
The brake is in the "locked" condition during de-energised condition. A 24VDC supply is required to "un-lock" the brake. See fig 4.

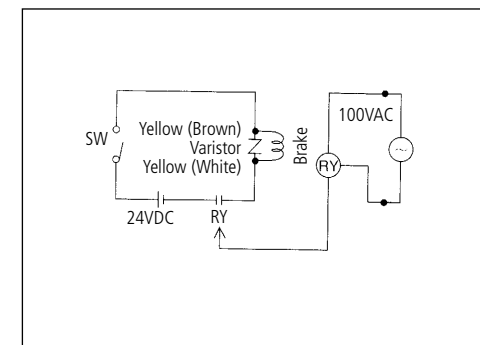

Fig 4

### Brake operation

Immediately stop the operation if unusual vibration or noise levels are experienced. The possibility is that the brake has been incorrectly mounted. Inspect the brake mounting and correct as necessary.

### Maintenance

#### CAUTION

If water or oil is applied to the sliding friction surface or brake body, the system may overrun and cause severe injury.

**Exclusive LX Series driver unit and LC6D (Fig 6)**

**Specifications**

	LC6D-220AD	LC6D-507AD
Power supply	24VDC±10%, 3A	24VDC±10%, 2.5A
Excitation (Step angle)*	Full step (1.8°) Half step (0.9°)	Full step (0.72°) Half step (0.36°)
Motor current	2.0/phase	0.75/phase
Input signal	Photo coupler input (input impedance 330Ω)	
Max. input frequency	10kHz at full step 20kHz at half step	
Function**	Auto current down*, power down input	
Connecting method	Connector	
Ambient temperature	5 to 40°C	
Ambient humidity	35 to 85% (no dewing)	
Corresponding actuator	LXSH2S□ LXPB2S□	LXFH5S□ LXSH5S□ LXPB5S□

\*Set by function change switch. Product is set as shown below when shipped from factory.

	ON	OFF
1	Half step	Full step
2	Release	Setting

\*\* Function:  
Auto current down: Function to automatically reduce 50% of current output to motor when stopped.  
Power down input: Current flow to motor is shut down by this input, and the motor goes to non-excitation state.

**Fig 6**

**Usage**

**WARNING**

- Operating manual should be read carefully to understand and confirm product specifications/characteristics before mounting.
- Avoid using equipment in any mounting method or operation other than that mentioned in the operating manual. Otherwise, it may cause failure and malfunction.
- Never touch the inside of the driver unit, it may cause electric shock or failure.
- Motor and driver should be used in the designated combinations.

**CAUTION**

- Do not disassemble nor modify the equipment. This may cause failure, malfunction or fire.
- Do not touch the driver during energizing or immediately after de-energizing due to high temperature.
- When fire or danger to operator is predicted, due to abnormal operation of the driver, isolate the power supply to the main body and system immediately.

**Usage**

**DANGER**

- Adjusting, mounting or wiring change must not be carried out before isolating the power supply to the driver. Electric shock may result.

**DANGER**

- Wiring should be properly carried out.
- Do not apply voltage to the terminals other than those specified in operating manual. Damage may occur.
- Connector should be correctly connected.

- Measures against noise should be taken. If noise is present on signal line, it may cause malfunction. As a countermeasure, separate power cables from signal wires and shorten the wiring length.

**Mounting**

**CAUTION**

- Mount the driver on non-combustible substance. Mounting directly on or closely to combustible material may cause fire.
- Cooling must be carried out so that operating temperature of the unit remains within the range shown in the specifications. For this reason, each face of the unit should be at least 50 mm from

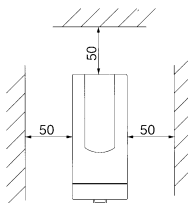

adjacent constructions or components.

- Unit must be grounded.
- Avoid mounting the driver on the panel where vibration source is present. If the driver is mounted on the same panel as a vibration source, it must be separated from the source.
- Design the machinery so that the connector can be freely connected/disconnected after installation.
- Use within the specifications. Do not use in environments where dusts, oil, smoke, conductive dusts, corrosive gas, flammable gas or so on are generated, in environments where exposed to high temperature, dewing, wind/rain or so on, or in environments where shock or vibration are conducted.

**Wiring example (Fig 7)**

Signal code	Function	Pin
+24V	Driver power supply +24V	7
GND	Driver power supply ground	6
CW+	CW pulse input terminal (+)	3
CW-	CW pulse input terminal (-)	10
CCW+	CCW pulse input terminal (+)	2
CCW-	CCW pulse input terminal (-)	9
PD+	Power down input terminal (+)	1
PD-	Power down input terminal (-)	8

Signal code	Function	Pin
A	Motor drive output A	5
B	Motor drive output B	4
C	Motor drive output C	14
D	Motor drive output D	13
E	Motor drive output E	12
F	Motor drive output F ("LC6D-2□□□" only)	11

**Fig 7**

**Mounting Method (Fig 7b)**

Applicable housing & contact example (Option)	Manufacturer
5557-14R, 5556PBT	Molex

**Fig 7b**

Should you require any additional information please contact your local SMC office, see below:

When you enquire about the product, please contact the following

SMC Corporation:			
ENGLAND	Phone 01908-563888	TURKEY	Phone 212-2211512
ITALY	Phone 02-92711	GERMANY	Phone 6103-402-0
HOLLAND	Phone 020-5318888	FRANCE	Phone 01-64-76-10-00
SWITZERLAND	Phone 052-396 31 31	SWEDEN	Phone 08-603 07 00
SPAIN	Phone 945-184100	AUSTRIA	Phone 02262-62-280
	Phone 902-255255	IRELAND	Phone 01-4501822
GREECE	Phone 01-3426076	DENMARK	Phone 70 25 29 00
FINLAND	Phone 09-68 10 21	NORWAY	Phone 67-12 90 20
BELGIUM	Phone 03-3551464	POLAND	Phone 48-22-6131847
		PORTUGAL	Phone 02-610 8922

**CAUTION**

**Incorrect usage (Fig 8)**

- Do not operate beyond the rated voltage range. If applying voltage over the rated voltage range, equipment may be damaged.

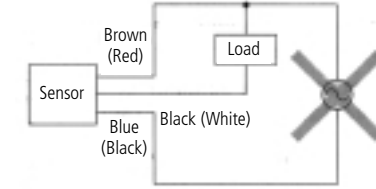

- Avoid incorrect wiring such as polarity of power supply. Otherwise equipment may be damaged.

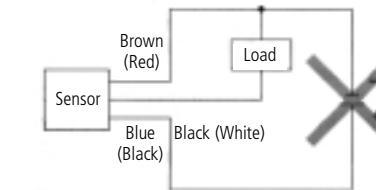

- Do not short circuit the load. (Do not connect to power supply). Otherwise equipment may be damaged.

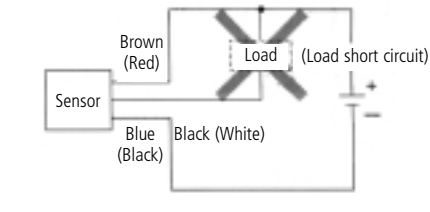

**Fig 8**

**CAUTION**

**Correct usage: Power supply (Fig 9a, b)**

The following conditions should be satisfied when using switch regulator.

- Mounting frame is connected to "0V" line of power supply close to the sensor to reduce impedance of the frame so that induction noise will not enter the mounting frame.

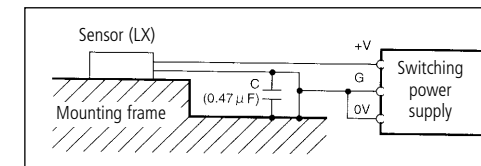

**Fig 9a**

- Noise filter terminal (neutral terminal to "ACG") on switching power supply is connected to the power supply's body frame "FG" and "0V" of the power supply.

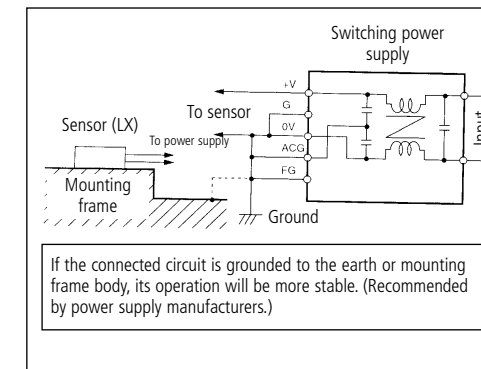
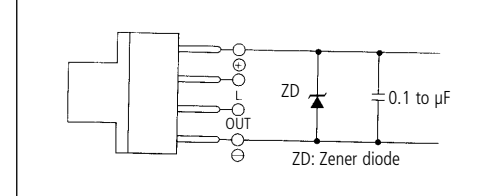

**Fig 9b**

- Insert an approximately 10mm width insulation plate made of plastics in between sensor body and mounting frame.

**CAUTION**

**Correct usage: Surge voltage (Fig 10)**

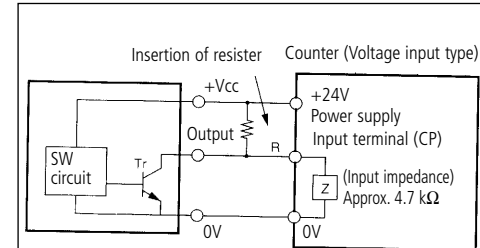

**Fig 10**

If surge voltage is generated on the power supply line, according to the operating conditions, circuit should be equipped with zener diode "ZD", 30 to 35V, or condenser, 0.1µF, etc. in order to eliminate the surge voltage. Do not start the operation before confirming disappearance of surge voltage.

**CAUTION**

**Correct usage: Voltage output Fig 11**



In the case resistor R=4.7 kΩ  
At "H" level,  
Input voltage VH

$$= \frac{Z}{R+Z} V_{cc} = \frac{4.7k}{4.7k+4.7k} \times 24V = 12V$$

At "L" level,  
Input voltage VL ≤ 0.4V  
Load voltage Vc

$$= \frac{V_{cc}}{R} = \frac{24V}{4.7k} = 5.1mA \leq 10mA$$

\* See the sensor specifications for residual voltage against load voltage.

**Fig 11**

**CAUTION**

If operating with a small dielectric load such as a relay etc., wire as shown in figure 10.

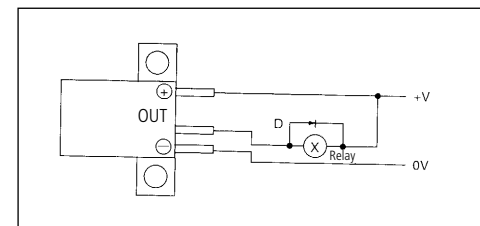

**Fig 12**

NOTE: A reverse voltage suppression diode should be installed.

**Maintenance**

**WARNING**

- Ensure all power supplies are ISOLATED before commencing any maintenance work.