



Installation & Maintenance Manual

Pressure Sensor Controller

Series PSE300



Safety Instructions

The Pressure Sensor Controller and this manual contain essential information for the protection of users and others from possible injury and property damage and to ensure correct handling. Please check that you fully understand the definition of the following messages (signs) before going on to read the text, and always follow the instructions. Please read the operation manuals of related apparatus and understand it before operating the controller.

IMPORTANT MESSAGES

Read this manual and follow its instructions. Signal words such as WARNING and NOTE, will be followed by important safety information that must be carefully reviewed.

⚠ WARNING	Indicates a potentially hazardous situation which could result in death or serious injury if you do not follow instructions.
NOTE	Gives you helpful information.

⚠ WARNING

Do not disassemble, remodel (including change of printed circuit board) or repair.

An injury or failure can result.

Do not operate beyond specification range.

Fire, malfunction or controller damage can result. Please use it after confirming the specification.

Do not operate in atmosphere of an inflammable, an explosive and corrosive gas.

Fire, an explosion and corrosion can result. This controller is not an explosion-proof type.

Prepare the double interlock by another system (Mechanical interlock etc.) and check operating normally, when using this controller for an interlock circuit.

An accident by a malfunction may potentially result.

These instructions must be followed while in maintenance: Turn off the power supply, stop the supplied air, exhaust the residual pressure and verify the release of air before performing maintenance.

Otherwise an injury can be result.

Safety Instructions (continue)

NOTE

Follow the instructions given below when handling your controller. Otherwise, the controller may be damaged or may fail, thereby resulting in malfunction.

- Do not drop, bring into collision with other objects or apply excessive shock to the unit (100m/s² or more).
- Do not pull the lead wire with force or lift the controller by holding the lead wire.
- Do not use in a place in which oil or chemical splashes may occur.
- Connect wires and cables correctly.
- Do not perform wiring while power is on.
- Do not use wire or cable with power cable or high-voltage cable in the same route.
- Connect Terminal FG to ground when using a switching regulator obtained on the commercial market.
- Insert a noise filter (line noise filter, ferrite element or other element) between the switching regulator and controller when analog output is used.
- Do not insert or remove the sensor (connector) with the power ON.
- Do not press the setting buttons with a sharp pointed object.
- Warm-up for 20 to 30 minutes before detecting fine pressure. Some initial drift occurs during 20 to 30 minutes after turning the power ON.
- For 3 seconds after power is turned ON the measurement output will be OFF. This includes after momentary disconnection of power, by reset, etc).
- The direct-current power supply to combine should use UL authorization power supply which is the class 2 power supply based on UL1310 or the power supply is using the transformer of a class 2 based on UL1585.

Specification

PSE30*					
Pressure Range (*1)	For compound	For vacuum	For low pressure	For positive	For low differential
Rated Pressure Range	-100 to 100kPa	0 to -101kPa	0 to 100kPa	0 to 1MPa	0 to 2kPa
Set Pressure Range	-101 to 101kPa	10 to -101kPa	-10 to 100kPa	-0.1 to 1MPa	-0.2 to 2.00kPa
Set pressure resolution	0.2kPa	0.1kPa	0.1kPa	0.001MPa	0.01kPa
Power Supply Voltage	12 to 24VDC, ripple (p-p) 10% or less (Protected against inverse connection)				
Current Consumption	50mA or less (No load)				
Sensor Input Signal	1 to 5VDC (Input impedance: 1MΩ) Input Protection: With over voltage protection (Max. 26.4V)				
Switch Output	NPN or PNP open collector output, 2 output				
Max. Load Current	80mA				
Max. Applied Voltage	30VDC (@ NPN output)				
Residual Voltage	1V or less (@ 80mA load current)				
Response Time	1ms (chattering-proof function working: 20, 160, 640, 1280ms selected)				
Short Circuit Protection	Provided				
Repeatability	±0.1% F.S. or less				
Analog Output	Voltage Output (*2)	Output Voltage: 1 to 5V (within rated pressure range) Output impedance: approx. 1kΩ, Linearity: ±0.2%F.S. (Without sensor) Response time: less than 150ms			
	Accuracy	±0.6%F.S.		±1.0%F.S. ±1.5%F.S.	
	Current Output (*3)	Output Current: 4 to 20mA (within rated pressure range), Max. Load Impedance: 300Ω (@ power supply voltage of 12VDC) 600Ω (@ power supply voltage of 24VDC) Min. Load Impedance: 50Ω Linearity: ±0.2%F.S. (Without sensor) Response time: less than 150ms			
Accuracy	±1.0%F.S.		±1.5%F.S. ±2.0%F.S.		
Auto shift input (*4)	Non-Voltage input (reed or solid state), Low level input 5ms or more, Low level 0.4V or less				
Hysteresis	Hysteresis Mode: Variable, Window Comparator Mode: Variable				
LCD Display	3 1/2 digits 7-segment display, Dual-color display (red/green), Sampling rate: 5times/1sec				
Indicator Accuracy	±0.5% F.S. ±2digits		±0.5% F.S. ±1digit		
Indicator	OUT1: Illuminate ON (green), OUT2: Illuminate ON (red)				
Temp. Characteristic	±0.5% F.S. or less of detected pressure (25°C)				

*1: Select pressure range by the initialization.

*2: For PSE300 and PSE303.

*3: For PSE301 and PSE304.

*4: For PSE302 and PSE305.

PSE30*					
Pressure Range (*1)	For compound	For vacuum	For low pressure	For positive	For low differential
Rated Pressure Range	-100 to 100kPa	0 to -101kPa	0 to 100kPa	0 to 1MPa	0 to 2kPa
Set Pressure Range	-101 to 101kPa	10 to -101kPa	-10 to 100kPa	-0.1 to 1MPa	-0.2 to 2.00kPa
Set pressure resolution	0.2kPa	0.1kPa	0.1kPa	0.001MPa	0.01kPa
Enclosure	IP40				
Ambient Temp. Range	Operation: 0 to 50°C, Storage: -10 to 60°C (No condensation or freezing)				
Ambient Humidity Range	Operation Storage: 35 to 85% RH (No condensation)				
Withstand Voltage	1000VAC, 1 minute (between lead block and case)				
Insulation Resistance	50MΩ or more (500VDC by megameter) (between lead block and case)				
Vibration proof	10 to 150Hz smaller one 1.5mm or 98m/s ² double amplitude each in directions of X, Y and Z for 2 hours				
Impact proof	100m/s ² , 3 times each in directions of X, Y and Z respectively				
Material	Front case : PBT, Back case : PBT				
Mass (Weight)	Approx. 30g (Power and output lead wire and sensor lead wire not included)				

Model Indication Method

PSE30□-□□□□

Option 3

- No Symbol : None
- C : E-con connector for Sensor (ZS-28-C)

Option 2

- No Symbol : None
- A : Bracket (ZS-28-B)
- B : Panel Mount Adapter (ZS-27-C)
- D : Panel Mount Adapter with Front Protective Cover (ZS-27-D)

Option 1

- No Symbol : None
- L : Power and Output Lead Wire (ZS-28-A)

Units Specification

- No Symbol : Unit selection function provided (NOTE 1)
- M : SI units fixed (NOTE 2)

Input / Output Specification

- 0 : NPN open collector 2 outputs + 1 to 5VDC Analog Output
- 1 : NPN open collector 2 outputs + 4 to 20mA Analog Output
- 2 : NPN open collector 2 outputs + Auto Shift Input
- 3 : PNP open collector 2 outputs + 1 to 5VDC Analog Output
- 4 : PNP open collector 2 outputs + 4 to 20mA Analog Output
- 5 : PNP open collector 2 outputs + Auto Shift Input

NOTE 1: The new Measurement Law prohibits use in Japan of controller with a unit selection function.

NOTE 2: Fixed unit for compound, vacuum, low and differential pressure is : kPa for positive pressure is : MPa (kPa for 500kPa range model)

Outline with Dimensions (in mm)

Dimensions of Pressure Sensor Controller

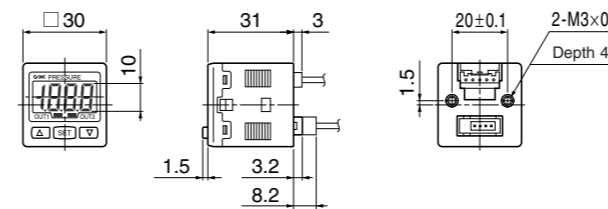

Mounting using mounting option

Mounting by bracket

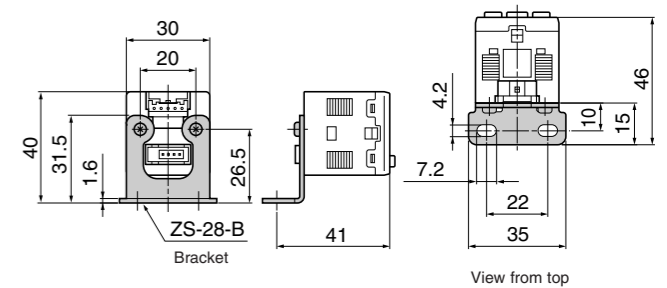

Panel Mount Type

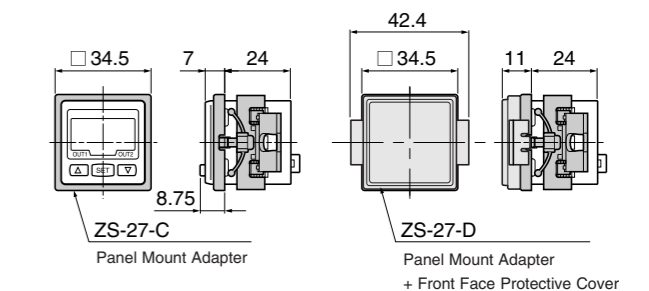

Names and Functions of Individual Parts

Main Unit

Output (OUT1) Lamp (Green): Lit when OUT1 is ON.

Output (OUT2) Lamp (Red) : Lit when OUT2 is ON.

LCD Display : Displays the current status of pressure, setting mode, selected indication unit and error code. Four display modes can be selected: display always in red or green only, or changing from green to red linked to output.

△ Button : Selects the mode and increases a set ON/OFF value. Press this button to change to the peak display mode.

▽ Button : Selects the mode and decreases a set ON/OFF value. Press this button to change to the bottom display mode.

SET Button : Changes the mode and sets a set value.

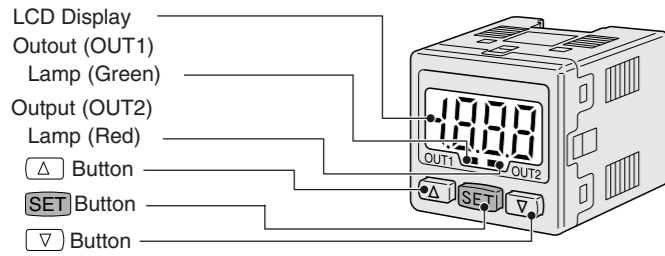

Options

Power and Output Lead Wire with Connector (2m) : ZS-28-A

Connector for Sensor Lead Wire (1pc) : ZS-28-C

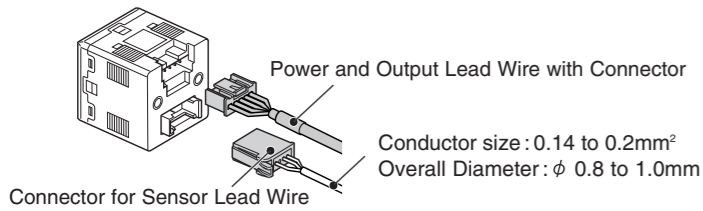

Bracket with set screws M3 × 5L (2pcs) : ZS-28-B

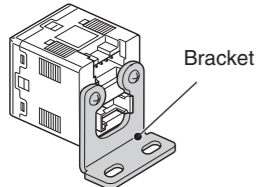

Panel Mount Adapter with set screws M3 × 8L (2pcs) : ZS-27-C

Panel Mount Adapter with set screws M3 × 8L (2pcs)

+ Front Face Protective Cover : ZS-27-D

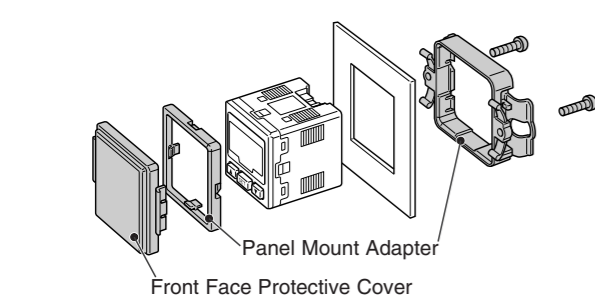

Installation

Mounting

•Mount the optional bracket and panel mount adapter to the controller.

Mounting by bracket

•Fix the bracket to the controller with the set screws M3 × 5L (2pcs) as attached.

•The tightening torque of the set screws must be 0.5 to 0.7N-m.

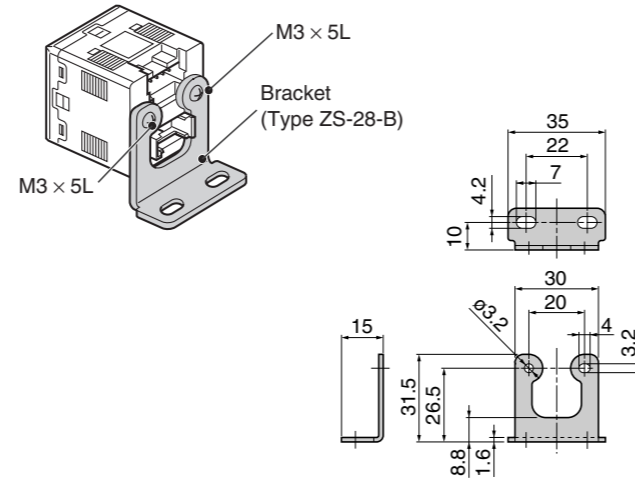

Mounting by Panel mount adapter

•Fix the panel mount adapter to the controller with the set screws M3 × 8L (2pcs) as attached.

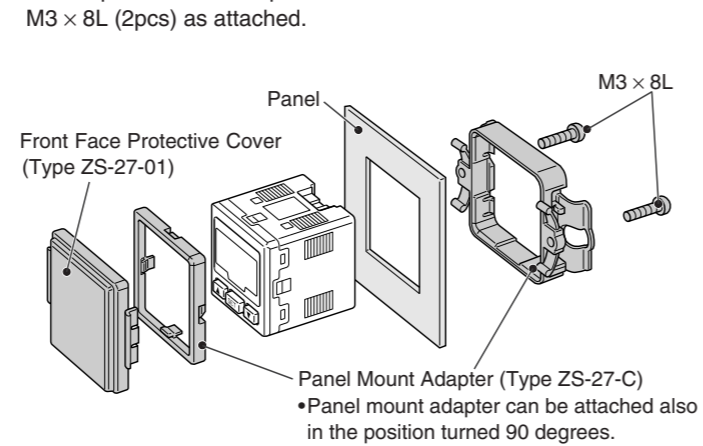

Notice when removing the controller

• The controller with adapter for panel mounting can be removed from panel by releasing hooks at the controller sides as illustration after removing two screws. Pressure sensor controller and Panel mount adapter may be damaged if hooks are not released.

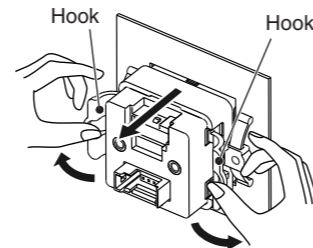

Panel Cut Dimensions

Separate

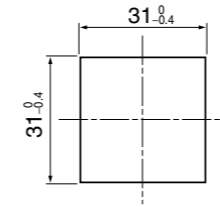

Panel Thickness: 0.5 to 6mm

Two or more in row

n : The number of controllers

Horizontal

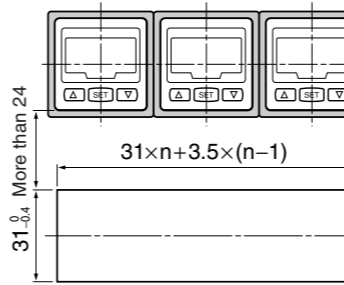

Vertical

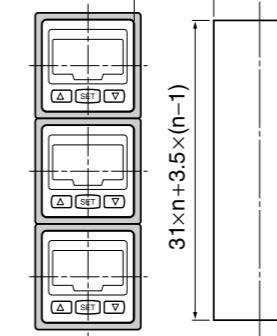

Attaching connector to sensor lead wire

- Strip the sensor wire as shown in the right figure.
- The core of the corresponding color shown in the following table is put into the pin of the number printed on the e-con connector, and pushed to the back.

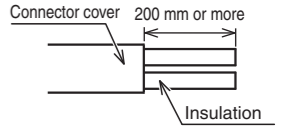

Pin No.	Wire Color
1	Brown (DC +)
2	NC
3	Blue (DC -)
4	Black (IN : 1 to 5VDC)

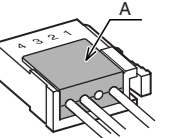

- Check that the above-mentioned preparation work has been performed correctly, then part A shown in the figure is pushed in by hand to make temporary connection.
- Part A center is pressed straight in using a tool, such as pliers.
- Re-use cannot be performed once the e-con connector has been completely crimped.
- In case of connection failure such as incorrect order of wires or incomplete insertion, please use a new e-con connector.

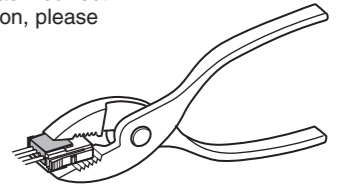

Connection

- Make connection after turning the power off.
- Install the lead wire separately from the route for power cable or high-voltage cable. Otherwise, malfunction may potentially result due to noise.
- Be sure to ground Terminal FG when using a switching regulator obtained on the commercial market. If the analog output is connected to a switching regulator obtained on the market, switching noise will be superimposed and product specification can no longer be met. This can be prevented by inserting a noise filter, such as a line noise filter and a ferrite element, between the switching regulator and the controller, or by using a series power supply instead of a switching regulator.

Internal Circuit and Wiring

Connector Connecting/Disconnecting

- When connecting the connector, insert it straight onto the pins and lock the connector into the square groove in the housing unit connector clicks.
- When disconnecting the connector, press the connector lever to disengage the lever claw from the square groove. Then pull the connector straight out.

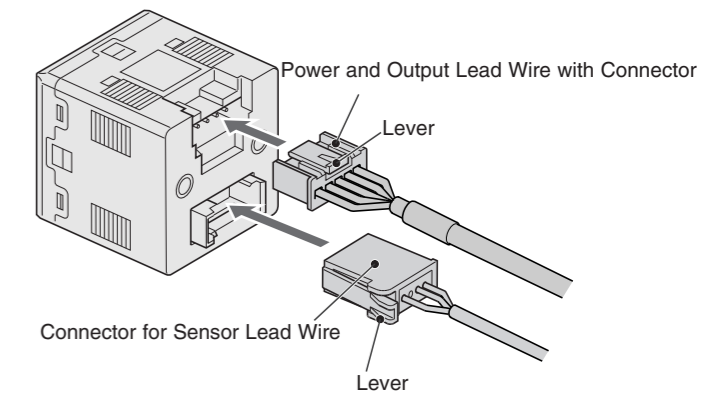

Power and Output Connector pin numbers

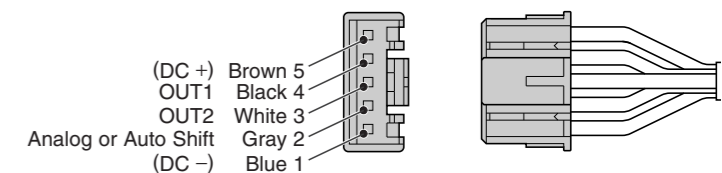

Example of Internal Circuit and Wiring (continue)

Output Specification

When the SMC Power and Output Lead Wire (type ZS-28-A) is used, the colors of wire (Brown, Black, White, Gray, Blue) will apply as shown on circuit diagram.

PSE300

- NPN Open Collector Output:
- 2 Outputs
- Max. 30V, 80mA
- Residual voltage 1V or less
- Analog Output :
- 1 to 5V
- Output Impedance:
- Approx.1kΩ

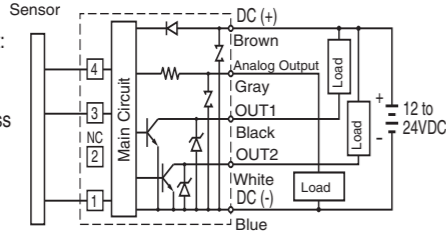

PSE301

- NPN Open Collector Output:
- 2 Outputs
- Max. 30V, 80mA
- Residual voltage 1V or less
- Analog Output:
- 4 to 20mA
- Max. Load Impedance :
- 300Ω (@12VDC), 600Ω (@24VDC)
- Min. Load Impedance :
- 50Ω

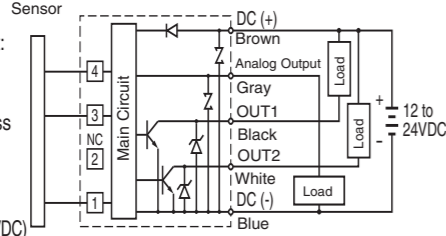

PSE302

- AUTO SHIFT Input
- Voltage Free Contact
- NPN Open Collector Output:
- 2 Outputs
- Max. 30V, 80mA
- Residual voltage 1V or less

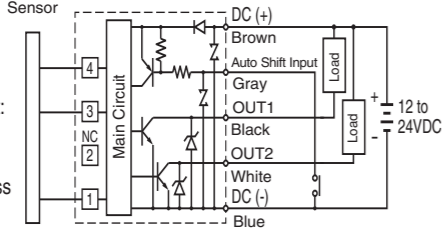

PSE303

- PNP Open Collector Output:
- 2 Outputs
- Max. 80mA
- Residual voltage 1V or less
- Analog Output:
- 1 to 5V
- Output Impedance :
- Approx.1kΩ

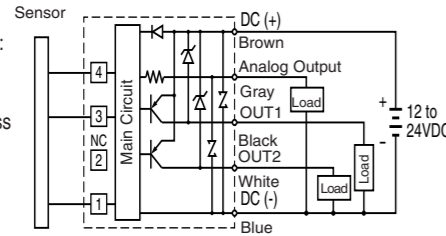

PSE304

- PNP Open Collector Output:
- 2 Outputs
- Max. 80mA
- Residual voltage 1V or less
- Analog Output:
- 4 to 20mA
- Max. Load Impedance :
- 300Ω (@12VDC), 600Ω (@24VDC)
- Min. Load Impedance :
- 50Ω

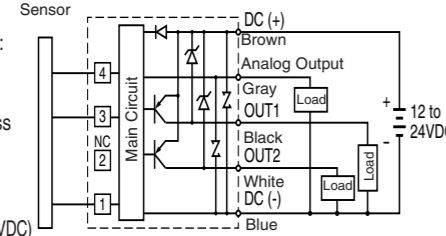

PSE305

- AUTO SHIFT Input
- Voltage Free Contact.
- PNP Open Collector Output:
- 2 Outputs
- Max. 80mA
- Residual voltage 1V or less

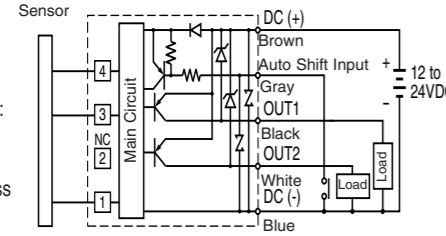

Setting

Setting Procedures

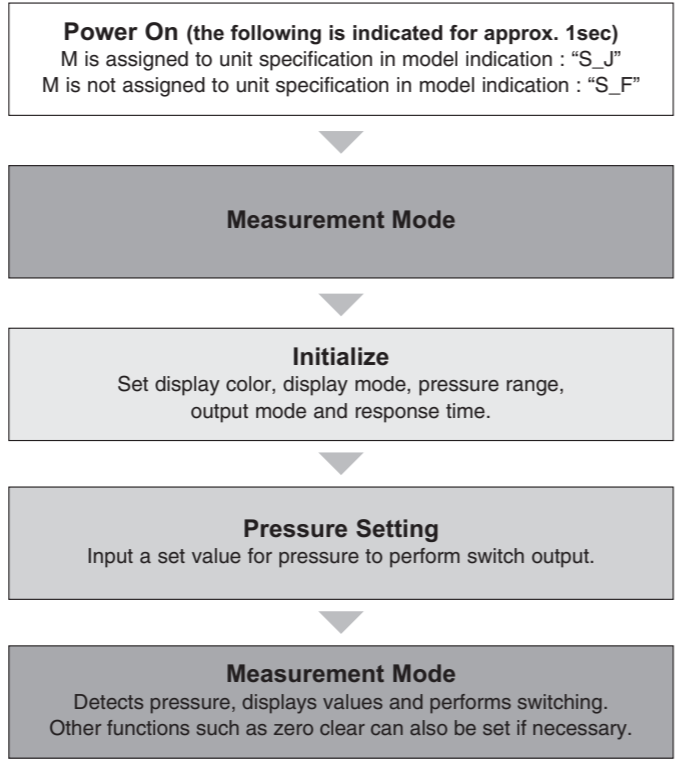

Initialize

Press and hold the **SET** button longer than two seconds. Release the **SET** button when [Sor] is displayed and initialization can begin.

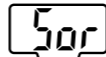

1.Display Color Setting

Select a color for the LCD display. When changing the display color, press the **Δ** or **▽** button to select a display color. Press the **SET** button to set the desired display color.

Sor (Red/ON) ⇔ SoG (Green/ON) ⇔ rEd (Red) ⇔ Grn (Green)

2.Output linked to display color Setting

Select output linked to display color, press the **Δ** or **▽** button and select output. Press the **SET** button to set.

(OUT1) C1 ⇔ C2 (OUT2)

3.Pressure Range Setting

Select the pressure range suitable for the sensor connected. Press the **Δ** or **▽** button and select the pressure range. Press the **SET** button to set. (Refer to the manual for the labels printed on the display part)

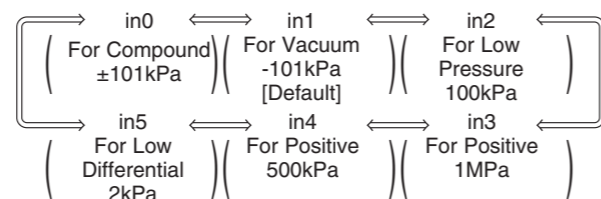

4. Selecting Display Unit

(When [-M] is not assigned to unit specification in model indication)

Selecting Display Unit

The indication unit can be selected freely. Pressing the **Δ** or **▽** button will change the unit and will automatically convert set values. Press the **SET** button to set and to move to setting the output mode.

LCD Display	PA	GF	bAr	PSi	inH	mmHg
For compound and vacuum	kPa	kgf/cm ²	bar	psi	inchHg	mmHg
For low pressure	kPa	kgf/cm ²	bar	psi		
For positive (*1)	MPa:kPa	kgf/cm ²	bar	psi		
For low differential	kPa					mmH2O

*1: MPa for 0 to 1MPa range model, kPa for 0 to 500kPa range model.

5. Output Method Setting

- Four output modes can be selected by operating mode and by output style. One of these four output modes can be selected for each output.
- OUT1 and OUT2 can be set independently.
- Refer to Output Mode Selection on next page.

1) To set operating mode for OUT1.

- Press the **Δ** or **▽** button and select the hysteresis mode or the window comparator mode.
- Press the **SET** button to set.

(Hysteresis) 1Hy ⇔ 1Un (Window Comparator)

2) To set output style for OUT1.

- Press the **Δ** or **▽** button and select the normally open or the normally closed setting.
- Press the **SET** button to set.

(Normally open) 1no ⇔ 1nC (Normally closed)

3) To set operating mode and output style for OUT2.

- Press the **Δ** or **▽** button and the **SET** button to set, as for OUT1 above.

(Hysteresis) 2Hy ⇔ 2Un (Window Comparator)

(Normally open) 2no ⇔ 2nC (Normally closed)

Output Mode Selection

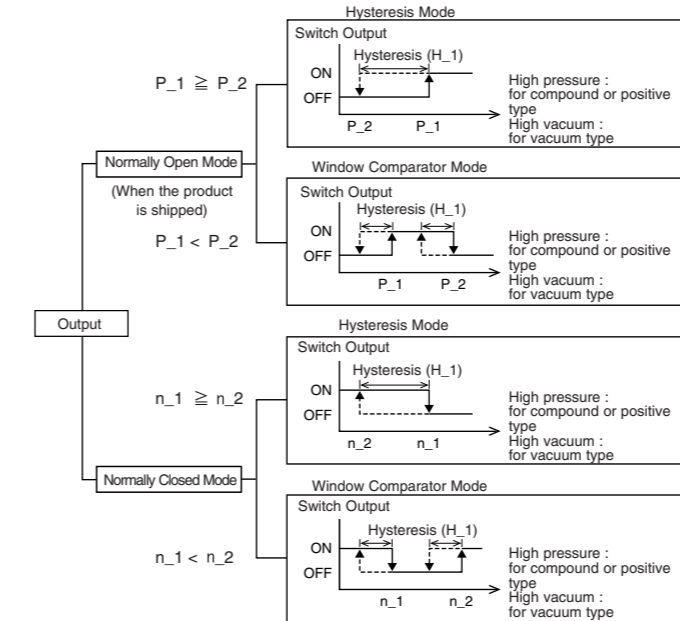

- When setting in the Auto Presetting mode, the Hysteresis mode will be set automatically.
- The following is given using OUT1 as an example. The descriptions for OUT2 are the same as those for OUT1, under the conditions that [n_1] and [n_2] should be replaced by [n_3] and [n_4], [P_1] and [P_2] should be replaced by [P_3] and [P_4] and [H_1] should be replaced by [H_2].

6.Response Time Setting

- A response time for switch output can be set as user desires.
- Set the optimum response time to prevent the chattering of a switch. The response time currently set will be displayed. Select a desired response time by pressing the **Δ** or **▽** button. Press the **SET** button to set.

1 ⇔ 20 ⇔ 160 ⇔ 640 ⇔ 1280

7.Pressure setting

- There are two methods for pressure set-up : manual and auto preset, either one of which can be selected. The auto preset is provided for an automatic optimum set-up by using a sample for a case in which switch output is used to check absorption.
- An operation mode currently selected is displayed. Press the **Δ** or **▽** button to select the set-up method to be used. Press the **SET** button to set.

(Manual Setting) nAn ⇔ AuT (Auto Preset)

8.Auto Shift setting (PSE302 / 305 model only)

1) Select the display mode of the pressure value at the time of auto shift operation.

Either [AS (Auto Shift)] or [ASO (Auto Shift Zero)] can be selected. AS (Auto Shift) : [AS] displays the differential pressure of the atmosphere and measurement pressure.

ASO (Auto Shift Zero) : [ASO] displays the differential pressure of the measurement pressure and the measurement pressure at the time of auto shift signal input.

- Press the **Δ** or **▽** button to select the Auto Shift or Auto Shift zero. Press the **SET** button to set.

(Auto Shift) AS ⇔ ASO (Auto Shift Zero)

2) To select the switch to which Auto Shift mode applies, when the auto shift signal is input.

- Press the **Δ** or **▽** button to select the A1, A2 or Ab. Press the **SET** button to set.

A1 (OUT1) ⇔ A2 (OUT2) ⇔ Ab (both OUT1 and OUT2)

- The initial setting is now completed and the controller will return to the Measurement mode.

Pressure setting mode

Manual Setting

Manually select a set value of the controller.

1. Selection of OUT1 [P_1] setting mode

- Press the **[SET]** button during the Measurement mode to display set values. 
- [P_1] and the current set value will display alternately. (When the Normally Closed mode is selected in initialization, [n_1] and the set value will display alternately.)
- Press the **[Δ]** or **[∇]** button to enter into the Value Changing mode, then change the set value. (See “Value Setting”)
- Check the corrected value, then press the **[SET]** button.

2. Selection of OUT1 [P_2] setting mode (Window comparator mode selected)

- [P_2] and the current set value will display alternately. (When the Normally Closed mode is selected in initialization, [n_2] and set value will display alternately)
- Press the **[Δ]** or **[∇]** button to enter into the Value Changing mode, then change the set value. (See “Value Setting”)
- Check the corrected value, then press the **[SET]** button. 

3. Selection of OUT1 [H_1] setting mode

- [H_1] and the current set value will display alternately.
- Press the **[Δ]** or **[∇]** button to enter into the Value Changing mode, then change the set value. (See “Value Setting”) 
- Check the corrected value, then press the **[SET]** button.

4. Selection of OUT2 setting mode

- Set the set values [P_3] [P_4] and [H_2] of OUT2 as in OUT1. [P_3] [P_4] or [H_2] and current set value will display alternately. (When the Normally Closed mode is selected in initialization, [n_3] [n_4] or [H_2] and set value will display alternately)
- Press the **[Δ]** or **[∇]** button to enter into the Value Changing mode, then change the set value. (See “Value Setting”)
- Check the corrected value, then press the **[SET]** button.

5. Auto shift compensation value setting (PSE302 / 305 model only)

- [C_5] and Auto shift corrected value will display alternately. 
- Check the corrected value, then press the **[SET]** button.

The pressure setting is now completed and the controller will return to the Measurement mode.

Value Setting



To input a value for pressure setting or other purposes:

- Press the **[Δ]** or **[∇]** button to enter the Set Value Change mode. The first row will be flashing.
- Press the **[Δ]** or **[∇]** button to set the desired value. (No operation within thirty seconds after the Set Value Change mode was selected results in automatic setting of the value appearing in the display window and in a change of mode from Set Value Change mode to Set Value Indication mode.)
- Press the **[SET]** button to make the value one digit higher flashing. (If the highest place is zero, “i” or “j” will flash, “i” means “+zero”, “j” means “-zero”.) (In the case that the **[SET]** button is pressed in the highest digit, the first digit will flash.)
- Press the **[SET]** button continuously for longer than one second to memorize the set value and to return to displaying set values.

Auto Preset Setting

When auto preset is selected at initialization, this function stores in the memory a pressure setting value which is calculated from a measurement pressure as a reference value. The set value of controller is automatically set to an optimum value by repeating absorption and non-absorption several times with a sample which is to be set up. 

1. Selection of OUT1 auto preset mode

- Press the **[SET]** button to display [AP1]. (When OUT1 setting is not necessary, press **[Δ]** button and **[∇]** button simultaneously for longer than one second.)

2. Preparation of unit for OUT1

Prepare a sensor unit for which pressure for OUT1 is to be set.

3. Selection of auto preset value of OUT1 setting

- Press the **[SET]** button to display [A1L].
- Operate system so that the measured pressure may change.
- Detection will be made and a set value will be stored in the memory automatically and the display will indicate [A1H]. 

4. Selection of OUT2 auto preset mode

- Press the **[SET]** button to set [P_1],[P_2] ([n_1],[n_2] in Normally Closed mode) and display [AP2].
- (When OUT2 setting is not necessary, press **[Δ]** and **[∇]** button simultaneously for longer than one second.)

5. Preparation of unit for OUT2 and pressure setting

- Prepare a sensor unit for which pressure for OUT2 is to be set.
- Press the **[SET]** button to display [A2L].
- Detection will be made and a set value will be stored in the memory automatically and the display will indicate [A2H].

6. Set up of OUT2 auto preset value

- Press the **[SET]** button to set [P_3],[P_4] ([n_3],[n_4] in Normally Closed mode), and auto preset mode is finished.
- The controller will return to the Measurement mode.

A pressure setting value in auto preset is as follows in Normally Open mode with OUT1. (P_1 is n_1 in Normally Closed mode with OUT1.)

$$P_1 = \frac{A - (A - B)}{4} \quad A = \text{maximum pressure value}$$

$$H_1 = \frac{(A - B)}{2} \quad B = \text{minimum pressure value}$$

For OUT2 set-up, above P_1, n_1, and H_1 become P_3, n_3, and H_2 respectively.

Fine Adjustment Mode

(Fine Adjustment Function of Display Value)

- Press the **[SET]** button and **[∇]** buttons simultaneously for longer than two seconds in the Measurement mode. “FS” and current pressure Measurement value will display alternately.
- Press the **[Δ]** or **[∇]** button to change the set value. (The possible range of adjustment : ±5%R.D.)
- If no operation is made for longer than three seconds or the **[SET]** button is pressed, the controller will display the current pressure Measurement value which will then display alternately with “FS”.

- Press the **[SET]** button to display the adjusted value (percentage), which will then display alternately with “FSC”. 

- Press the **[SET]** button to set and return to the Measurement mode.

Other Functions

Auto shift function

When the source pressure fluctuates too much, the controller may not be able to operate normally. Auto shift is provided to compensate for the fluctuation of the source pressure.

The measured pressure becomes standard pressure value when auto shift input is received, this function can correct the set value of the switches.

With Auto Shift

Set auto shift input as Lo at the time pressure source change, in order to memorize the pressure change and to correct pressure set value, so that correct decision results.

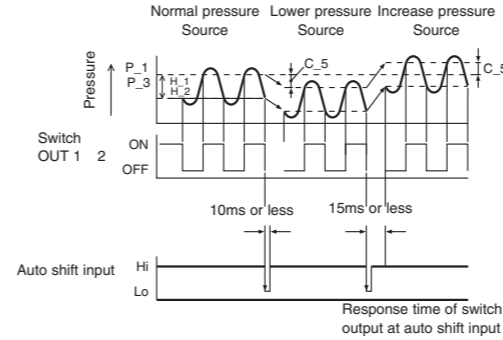

Conditions and explanations for auto shift function

- Keep constant pressure for 5ms or more from the close signal of auto shift input.
- At auto shift input, the pressure at that time is memorized to [C_5] as corrected value, and the switch operates with the value which applied compensation value to setting value. Display indicates [ooo] for approx.1 sec.
- The switch set to auto shift mode at the time of initial setting operates with the corrected value [C_5] applied to setting value.
- OUT1 will operate with Auto shift function, when “A1” is selected. The operating value of OUT1 applies corrected value [C_5] to [P_1],[P_2] or [n_1],[n_2].

OUT2 will operate with Auto shift function, when “A2” is selected. The operating value of OUT2 applies corrected value [P_3],[P_4] or [n_3],[n_4].

Both OUT1 and OUT2 will operate with Auto shift function, when “Ab” is selected. The operating value of OUT1 and OUT2 applies corrected value [P_1] to [P_4] or [n_1] to [n_4].

- There will be a delay of 10ms max. before switch output will respond to Auto shift input.
- When corrected set value exceeds the set pressure range with auto shift input, corrected value is not memorized and displays [o.r] for approx.1sec.
- Correct value [C_5] after auto shift input clears when the power is turned OFF.
- Correct value [C_5] when auto shift input function is reset to zero (Initial value) when power is re-supplied.
- When auto shift zero is selected, the display indicates [0] (zero) if the auto shift signal is input.

Note: There is no EEPROM in the memory for corrected value.

Using with auto shift input, accepted set range is like below.

	Set pressure range	Accepted set range
For compound	-101.0 to 101.0 kPa	-101.0 to 101.0 kPa
For vacuum	10.0 to -101.0 kPa	-101.0 to 101.0 kPa
For low pressure	-10 to 100.0 kPa	-100.0 to 100.0 kPa
For positive	-0.1 to 1.000 MPa	-1.000 to 1.000 MPa
	-50 to 500 kPa	-500 to 500 kPa
For low differential	-0.2 to 2.00 kPa	-2.00 to 2.00 kPa

Peak and Bottom Hold Display Function

Maximum and minimum values are always detected and updated during measurement. Displayed values can be held.

- In peak hold, press the **[Δ]** button for longer than one second.

This will hold the maximum pressure value, and display will flash. To reset holding, press the **[Δ]** button again for longer than one second. The controller will return to Measurement mode.

- In bottom hold, press the **[∇]** button for longer than one second.

This will hold the minimum pressure value, and display will flash.

To reset holding, press the **[∇]** button again longer than one second.

The controller will return to Measurement mode.

- Press and hold the **[Δ]** and **[∇]** buttons simultaneously longer than one second to reset the maximum or minimum pressure value.

Key Lock Function

This function prevents errors such as changing a set value by mistake.

Lock

- Press and hold the **[SET]** button longer than four seconds, Release the button when [UnL] is displayed. 
- Press the **[Δ]** or **[∇]** buttons to set the display to [LoC].
- Press the **[SET]** button and return to the Measurement mode.

Unlock

- Press and hold the **[SET]** button longer than four seconds. Release the button when [LoC] is displayed. 
- Press the **[Δ]** or **[∇]** buttons to change the display to [unL].
- Press **[SET]** the button and return to the Measurement mode.

Zero Clear Function

- A displayed value can be adjusted to zero when pressure to be measured is within ±7%F.S. of the atmospheric pressure. (There is variation in ±4digits according to the product characteristic.)
- Press and hold the **[Δ]** and **[∇]** buttons simultaneously longer than one second to reset to “0” on the display.
- The mode will return to the Measurement mode automatically.

Error Display Function

This function displays error location and nature when a problem or an error occurs.

Error name	Display of error	Contents	Disposition
Over current error	OUT 1 Er1	Over 80mA load current of a switch output flows.	Turn the power Off, check output to find cause of over current, and re-input power.
	OUT 2 Er2		
Residual pressure error	Er3	Performing zero reset, ±7%F.S. or more pressure applied to ambient pressure. *After 3 sec., measurement mode recovers automatically. There is variation in ±4digits according to the product characteristic.	After changing an applied pressure into ambient pressure, re-perform zero reset.
	HHH	Pressure over max. limit of set pressure range is applied or it is over the display range.	Set back an applied pressure into within set pressure range. While using the auto shift, even if it exceeds the display range, it can be used continuously.
Applied pressure error	LLL	Pressure below min. limit of set pressure range is applied or it is below the display range.	
Auto shift error	o.r	Corrected set value exceed limit of the accepted set range. *After 1 sec., measurement mode recovers automatically.	The controller does not respond to the auto shift signal. Check the unit again.
System error	Er4	Internal data error causes this display.	Turn power OFF, and re-input power. If this does not recover the operation, this error needs to be investigated by SMC.
	Er6	Internal data error causes this display.	
	Er7	Internal data error causes this display.	
	Er8	Internal data error causes this display.	

Contact

AUSTRIA	(43) 2262 62280	NETHERLANDS	(31) 20 531 8888
BELGIUM	(32) 3 355 1464	NORWAY	(47) 67 12 90 20
CZECH REP.	(420) 541 424 611	POLAND	(48) 22 211 9600
DENMARK	(45) 7025 2900	PORTUGAL	(351) 21 471 1880
FINLAND	(358) 207 513513	SLOVAKIA	(421) 2 444 56725
FRANCE	(33) 1 6476 1000	SLOVENIA	(386) 73 885 412
GERMANY	(49) 6103 4020	SPAIN	(34) 945 184 100
GREECE	(30) 210 271 7265	SWEDEN	(46) 8 603 1200
HUNGARY	(36) 23 511 390	SWITZERLAND	(41) 52 396 3131
IRELAND	(353) 1 403 9000	UNITED KINGDOM	(44) 1908 563888
ITALY	(39) 02 92711		

SMC Corporation

URL <http://www.smcworld.com> (Global) <http://www.smceu.com> (Europe)

Specifications are subject to change without prior notice from the manufacturer. © SMC Corporation All Rights Reserved.