



Installation & Maintenance Manual

Compact Pressure Sensor

Series PSE530



Safety Instructions

The Pressure Sensor and this manual contain essential information for the protection of users and others from possible injury and property damage and to ensure correct handling. Please check that you fully understand the definition of the following messages (signs) before going on to read the text, and always follow the instructions.

IMPORTANT MESSAGES

Read this manual and follow its instructions. Signal words such as WARNING and NOTE will be followed by important safety information that must be carefully reviewed.

WARNING

Indicates a potentially hazardous situation that could result in death or serious injury if you do not follow instructions.

NOTE

Gives you helpful information.

WARNING

Do not disassemble, modify (including change of printed circuit board) or repair.

An injury or failure can result.

Do not operate outside of the specification range.

Fire, malfunction or sensor damage can result. Please use after confirming the specification.

Do not operate in atmosphere of an inflammable, explosive or corrosive gas.

Fire, an explosion and corrosion can result. This pressure sensor is not an explosion proof type.

NOTE

Follow the instructions given below when handling the pressure sensor. Otherwise, the sensor may be damaged or may fail, thereby resulting in malfunction.

- Do not drop, bring into collision with other objects or apply excessive shock to the unit (980m/s² or more).
- Do not pull the lead wire with force or lift the main unit by holding the lead wire. (Pulling strength less than 23N)
- Do not insert wire or other articles into the pressure port.
- Connect wires and cables correctly.
- Do not perform wiring while power is on.
- Do not wire with power cable or high-voltage cable in the same wire route.
- Connect Terminal FG to ground when using a switching regulator obtained on the commercial market.
- Install the air tube correctly in a safe area away from water and dust.

Model Indication Method

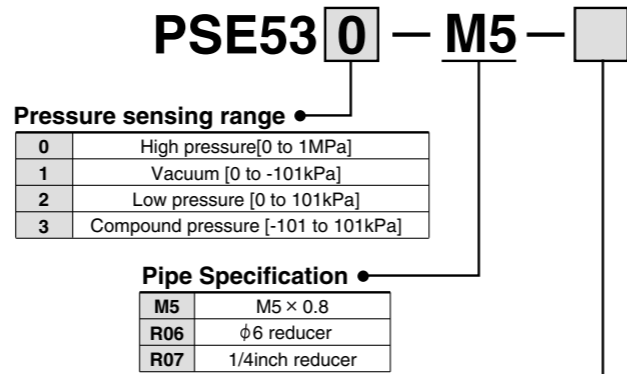

Option

Nii	Without cable
L	Sensor cable (3m), ZS-26-F
	Connector for sensor controller (1pc) + Sensor cable (3m), ZS-26-J
C2L	Connector for sensor controller (1pc) + Sensor cable (3m), ZS-26-J

Note) At the factory, the connector (ZS-28-C) is not connected to the cable, but packed together with it for shipment.

Outline with Dimensions (in mm)

PSE53□-M5

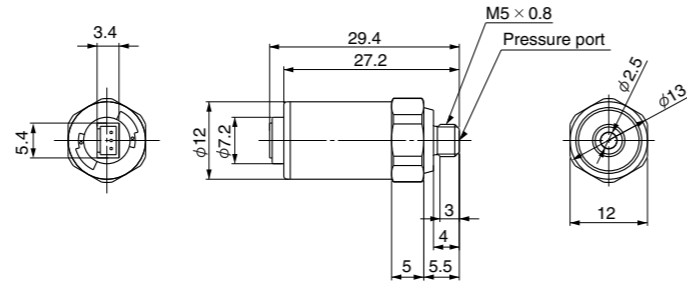

PSE53□-R06
R07

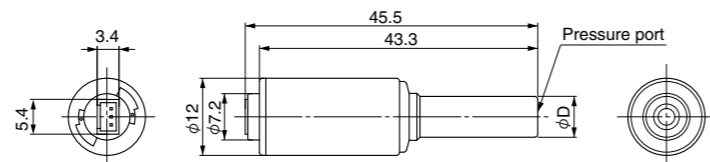

Model No.	Applicable port size(D)
PSE53□-R06	6mm
PSE53□-R07	1/4inch

With sensor cable fitted

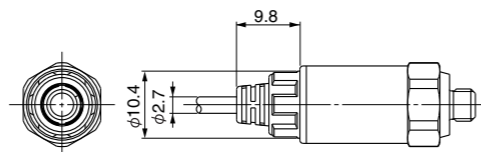

Specification

Model No.	PSE530-※	PSE531-※	PSE532-※	PSE533-※
Rated Pressure Range	0 to 1MPa	0 to -101kPa	0 to 101kPa	-101 to 101kPa
Withstand Pressure	1.5MPa	500kPa		
Fluid	Air, Non-corrosive gases, Non-flammable gases			
Power Supply	12 to 24VDC, ripple(p-p)10% or less (Protection against inverse connection)			
Current Consumption	15mA or less			
Analog Output	Voltage Output	Voltage: 1 to 5V ±2%F.S. or less (Rated pressure range) Linearity : ±1%F.S. or less Output impedance : Approx. 1kΩ		
Repeatability	±1%F.S. or less			
Power Supply Effect	±1%F.S. or less based on analog output at 18V in the range of 12 to 24VDC			
Temperature Characteristic	± 2%F.S. or less (25°C reference)			
Environment	Enclosure	IP40 (IEC 60529)		
	Ambient Temperature	Operation : 0 to 50°C, Storage : -10 to 70°C (No condensation, No freezing)		
	Withstand Voltage	1000VAC, 50/60Hz, 1minute (Between wires and case)		
	Insulation Resistance	5MΩ or more 500VDC (Between wires and case)		
Vibration Proof	10 to 500Hz 1.5mm or 98m/s ² acceleration, 2 hours each direction of X, Y and Z			
	Impact Proof	980m/s ² 3times each in directions of X, Y and Z respectively		
Standard	CE MARKING			
Cable	Halogen free heavy insulation cable, φ 2.7, 0.15mm ² , 3wire, 3m			

Material Specification

Model No.	M5	R06	R07
Port Size	M5 × 0.8	φ6 Reducer	1/4inch Reducer
Material	Pressure sensor : Silicon O-ring : NBR		
	Body : SUS303		Body : PBT
Weight	With cable(3m)	41g	38g
	Excluding cable	7g	3.8g

Analog output

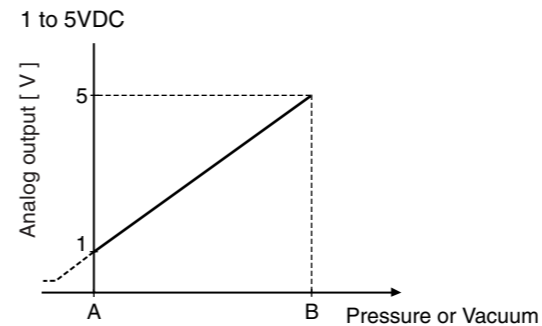

Model No.	PSE530-※	PSE531-※	PSE532-※	PSE533-※
Rated pressure range	0 to 1MPa	0 to -101kPa	0 to 101kPa	-101 to 101kPa
A	0kPa	0kPa	0kPa	-101kPa
B	1MPa	-101kPa	101kPa	101kPa

Installation

Observe the specified tightening torque when connecting pipes. Refer to the following table for the appropriate torque values.

Nominal size of Thread	Tightening torque N • m
M5	1/6 rotations after tightening by hand

When connecting pipeline to the sensor, apply a spanner vertically to the piping section of the sensor. Install the air piping correctly in a safe area away from water and dust.

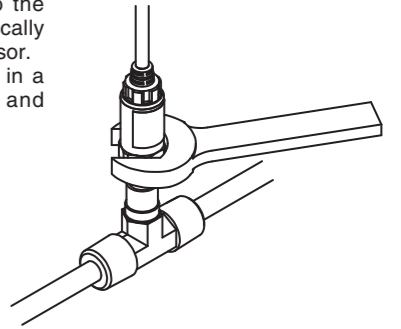

Hold the sensor and insert it into the one-touch fitting carefully and securely all the way to the bottom.

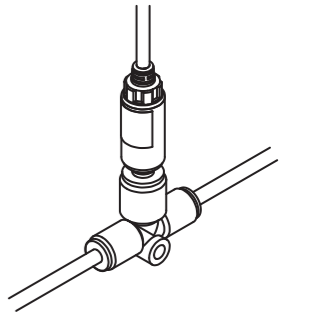

Installation (continue)

Attaching the connector to the lead wire

- Strip the sensor wire as shown in the right figure.
- The core of the corresponding color shown in the following table is put into the pin of the number printed on the e-con connector and pushed to the back.

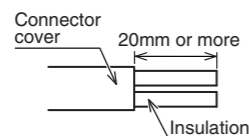

Pin No.	Color of Insulation
1	Brown (DC +)
2	N.C.
3	Blue (DC -)
4	Black (IN:1 to 5VDC)

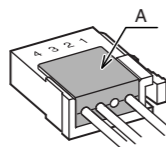

- Check that the above-mentioned preparation work has been performed correctly, then Part A shown in the figure is pushed in by hand to make temporary connection.
- Part A center is pressed straight in using a tool, such as pliers.
- Re-use cannot be performed once the e-con connector has been completely crimped.
- In case of connection failure such as incorrect order of wires or incomplete insertion, please use a new e-con connector.
- When connecting to PSE200/PSE300 controllers, please use the connector for sensor (ZS-28-C) or *e-con* as detailed below.

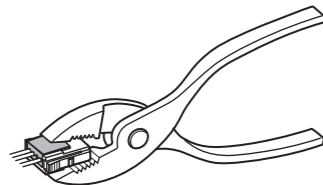

Manufacturer	Model No.
(c)Sumitomo 3M	37104-3101-000FL
Tyco Electronics AMP	3-1473562-4
OMRON	XN2A-1430

- Please contact connector manufacturer about *e-con* catalogue.

Connector Connecting/Disconnecting

- When connecting the connector, insert it straight onto the pins holding the lever and connector body, and lock the connector by pushing the lever claw into the square groove in the housing until connector clicks.
- When disconnecting the connector, press the connector lever to disengage the lever claw from the square groove. Then pull the connector straight out.

PSE200 Series

PSE300 Series

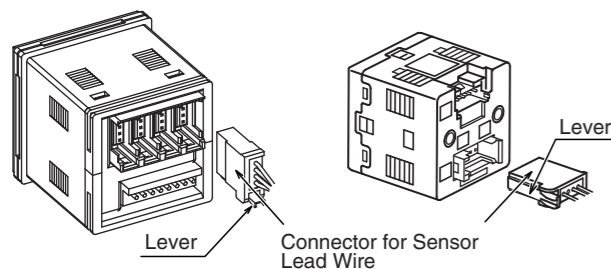

Internal Circuit and Wiring

Output Specification

Voltage output : 1 to 5V
 Output impedance : Approx. 1kΩ

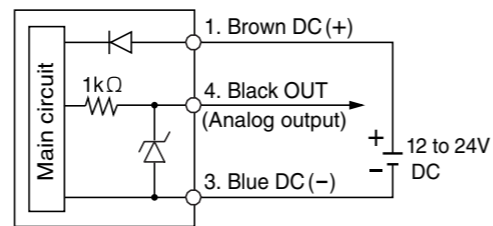

How to connect the sensor cable (Optional)

Hold the female connector on the sensor cable. Insert into sensor paying attention to the male connector direction.

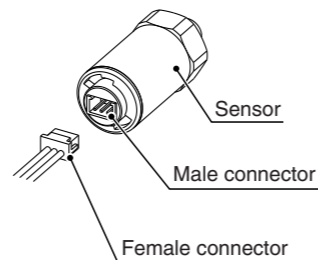

The sensor cable has a connector cover in order to prevent removal of the female connector. Paying attention to the connector cover direction, install on the sensor, rotate clockwise, and lock it. To remove cable for sensor, rotate the connector cover anti-clockwise, release the lock, and remove connector cover. After removing connector cover, hold the female connector with fingers and pull out.

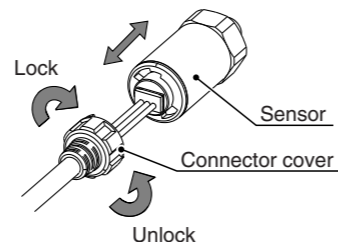

Contact

AUSTRIA	(43) 2262 62280	NETHERLANDS	(31) 20 531 8888
BELGIUM	(32) 3 355 1464	NORWAY	(47) 67 12 90 20
CZECH REP.	(420) 541 424 611	POLAND	(48) 22 211 9600
DENMARK	(45) 7025 2900	PORTUGAL	(351) 21 471 1880
FINLAND	(358) 207 513513	SLOVAKIA	(421) 2 444 56725
FRANCE	(33) 1 6476 1000	SLOVENIA	(386) 73 885 412
GERMANY	(49) 6103 4020	SPAIN	(34) 945 184 100
GREECE	(30) 210 271 7265	SWEDEN	(46) 8 603 1200
HUNGARY	(36) 23 511 390	SWITZERLAND	(41) 52 396 3131
IRELAND	(353) 1 403 9000	UNITED KINGDOM	(44) 1908 563888
ITALY	(39) 02 92711		

SMC Corporation

URL <http://www.smcworld.com> (Global) <http://www.smceu.com> (Europe)

Specifications are subject to change without prior notice from the manufacturer.
 © SMC Corporation All Rights Reserved.