



Installation & Maintenance Manual

Pressure Sensor

Series PSE560



Safety Instructions

The Pressure Sensor and this manual contain essential information for the protection of users and others from possible injury and property damage and to ensure correct handling. Please check that you fully understand the definition of the following messages (signs) before going on to read the text, and always follow the instructions.

IMPORTANT MESSAGES

Read this manual and follow its instructions. Signal words such as WARNING and NOTE will be followed by important safety information that must be carefully reviewed.

WARNING

Indicates a potentially hazardous situation that could result in death or serious injury if you do not follow instructions.

CAUTION

Indicates a potentially hazardous situation that, if not avoided, may result in minor injury or moderate injury.

NOTE

Gives you helpful information.

WARNING

Do not disassemble, modify (including change of printed circuit board) or repair.
An injury or failure can result.

Do not operate outside of the specification range.
Fire, malfunction or sensor damage can result. Please use after confirming the specification.

Do not operate in atmosphere of an inflammable, explosive or corrosive gas.
Fire, an explosion and corrosion can result. This pressure sensor is not an explosion proof type.

CAUTION

Check for fluid leaks after installing the sensor pipe.
Neglecting fluid leaks may cause a burn or damage to the machines and equipment

Use ferrule made by Crawford Fittings (Trade name:Swagelock®) for TSJ fittings, packing and glands made by Cajon (Trade name:Cajon VCR®) for URJ fittings.

Otherwise safety may not be secured due to leakage from joint. When using ferrules, packings or glands made by other manufacturer, be sure to perform helium leak test to verify no leakage.

NOTE

Follow the instructions given below when handling the pressure sensor. Otherwise, the sensor may be damaged or may fail, thereby resulting in malfunction.

- Do not drop, bring into collision with other objects or apply excessive shock to the unit (500m/s² or more).
- Do not pull the lead wire with force or lift the main unit by holding the lead wire. (Pulling strength less than 50N)
- Do not insert wire or other articles into the pressure port.
- Do not use in a place where oil or chemical splashes may occur.
- Connect wires and cables correctly.
- Do not perform wiring while power is on.
- Do not wire with power cable or high-voltage cable in the same wire route.
- Connect Terminal FG to ground when using a switching regulator obtained on the commercial market.
- Insert a noise filter (line noise filter, ferrite element or other element) between the switching regulator and pressure sensor.
- Do not use with inflammable gas or liquid.
- Only fluids which are Non-corrosive to SUS316L shall be used.
- Install the air tube correctly in a safe area away from water and dust.

Model Indication Method

PSE56 0 01

Pressure sensing range

0	Positive pressure (0 to 1 MPa)
1	Vacuum (0 to -101 kPa)
3	Compound pressure (-100 to 100 kPa)
4	Positive pressure (0 to 500 kPa)

Port size

01	R 1/8 (With M5 female thread)
02	R 1/4 (With M5 female thread)
C01	Rc 1/8
N01	NPT 1/8 (With M5 female thread)
N02	NPT 1/4 (With M5 female thread)
A2	URJ 1/4
B2	TSJ 1/4

Output specifications

Nil	Voltage output type 1 to 5V
28	Current output type 4 to 20mA

Option(Connector)

Nil	Without
C2	With connector for PSE200 or PSE300 pressure sensor controller (ZS-28-C) 1pc.

Note1) Current output type (PSE56*-28) cannot be connected to PSE200 or PSE300 controller.
Note2) The connector is not assembled to the cable but packed together with it for shipment.

Outline with Dimensions (in mm)

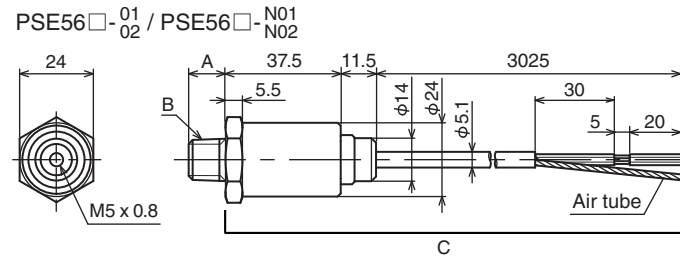

PSE56□-01 / PSE56□-N01 / PSE56□-N02

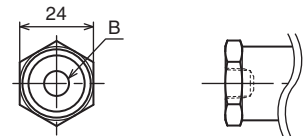

PSE56□-A2

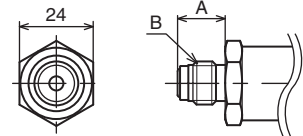

PSE56□-B2

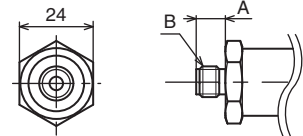

Model No.	A	B
PSE56□-01	8.2	R1/8
PSE56□-02	12	R1/4
PSE56□-N01	9.2	NPT1/8
PSE56□-N02	12.2	NPT1/4
PSE56□-C01	—	Rc1/8
PSE56□-A2	15.5	URJ1/4
PSE56□-B2	9.5	TSJ1/4

*The dimensions and length of C are the same.

Specification

	PSE560	PSE561	PSE563	PSE564
Rated Pressure Range	0 to 1MPa	0 to -101kPa	-100 to 100kPa	0 to 500kPa
Withstand Pressure	1.5MPa	500kPa	500kPa	750kPa
	PSE56-□□		PSE56--28□□	
Fluids	Air, Non-corrosive fluid, Non-flammable fluid			
Power Supply Voltage	12 to 24VDC, ripple (p-p) 10% or less (Protection against inverse connection)			
Current Consumption	10mA or less		—	
Analogue Output	1 to 5V (Rated Pressure range) Output impedance : Approx.1k		4 to 20mA (Rated Pressure range) Allowable load impedance 500Ω or less (24VDC) 100Ω or less (12VDC)	
Accuracy	± 1%F.S. or less (25°C)			
Linearity	± 0.5%F.S. or less			
Repeatability	± 0.2%F.S. or less (25°C)			
Temp. Characteristic	± 2%F.S. or less (0 to 50°C; 25°C), ± 3%F.S. or less (-10 to 60°C; 25°C)			
Enclosure	IP65 (IEC 60529)			
Ambient Temp. Range	Operation : -10 to 60°C, Storage : -20 to 70°C (No condensation or freezing)			
Ambient Humidity Range	Operation, Storage : 35 to 85%RH (No condensation)			
Withstand Voltage	250VAC, 1minute (Between wires and case)			
Insulation Resistance	50MΩ or more (50VDC M) (Between lead block and case)			
Vibration proof	10 to 150Hz 1.5mm or 20m/s ² acceleration, 2 hours each in directions of X,Y and Z			
Impact proof	500m/s ² , 3 times each in directions of X, Y, and Z respectively			
Lead wire	3-cores oil-resistance Vinyl cabtyre cable (0.2mm ²)		2-cores oil-resistance Vinyl cabtyre cable (0.2mm ²)	

Material Specification

Model No.	01	02	N01	N02	C01	A2	B2
Port size	R1/8, M5 x 0.8	R1/4, M5 x 0.8	NPT1/8, M5 x 0.8	NPT1/4, M5 x 0.8	Rc1/8	URJ1/4	TSJ1/4
Material	Case : C3604 + Ni, Piping port, Pressure Sensor : SUS316L						
Mass(Weight)	Approx. 205g						

Analogue output

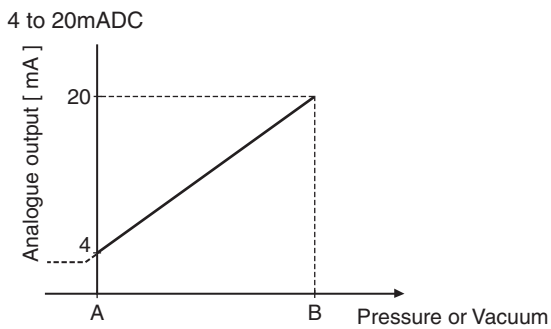
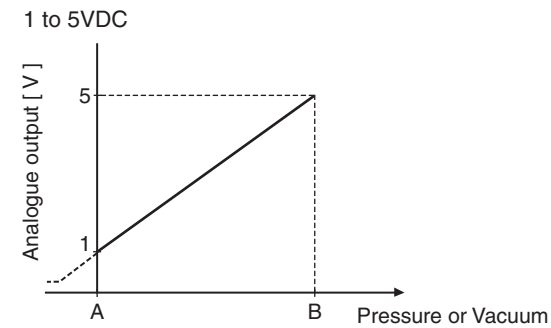

Model No.	PSE560-※	PSE561-※	PSE563-※	PSE564-※
Rated pressure range	0 to 1MPa	0 to -101kPa	-100 to 100kPa	0 to 500kPa
A	0MPa	0kPa	-100kPa	0kPa
B	1MPa	-101kPa	100kPa	500kPa

Installation

Observe the specified tightening torque when connecting pipes. Refer to the following table for the appropriate torque values.

Nominal size of Thread	Tightening torque N • m
R • NPT • Rc1/8	7 to 9
R • NPT • URJ • TSJ1/4	12 to 14

When connecting pipeline to the sensor, apply a spanner vertically to the piping section of the sensor. Install the air piping correctly in a safe area away from water and dust.

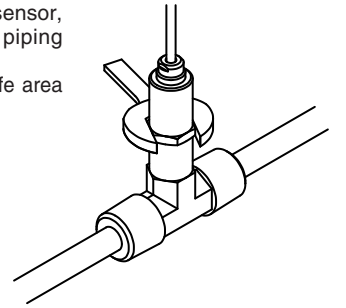

Internal Circuit and Wiring

Output Specification

PSE56□-□
Voltage output : 1 to 5V (±1%F.S.), Output impedance : Approx.1kΩ

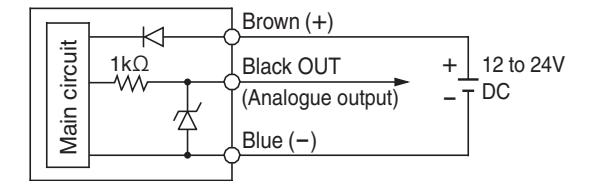

PSE56--28

Current output : 4 to 20mA (±1%F.S.)
Allowable load impedance : 500 Ω or less (Power supply 24VDC)
100 Ω or less (Power supply 12VDC)

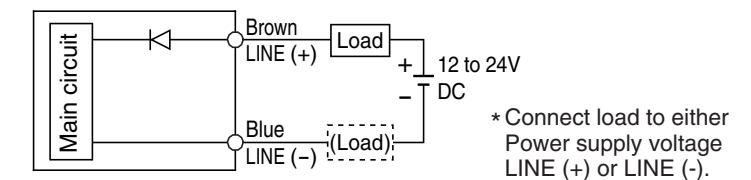

Installation (continue)

Attaching the connector to the lead wire

- Strip the sensor wire as shown in the right figure.
- The core of the corresponding color shown in the following table is put into the pin of the number printed on the e-con connector and pushed to the back.

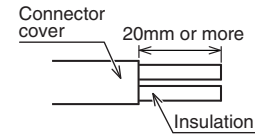

Pin No.	Color of Insulation
1	Brown (DC (+))
2	N.C.
3	Blue (DC (-))
4	Black (IN:1 to 5VDC)

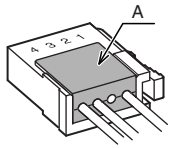

- Check that the above-mentioned preparation work has been performed correctly, then Part A shown in the figure is pushed in by hand to make temporary connection.
- Part A center is pressed straight in using a tool, such as pliers.
- Re-use cannot be performed once the e-con connector has been completely crimped.
- In case of connection failure such as incorrect order of wires or incomplete insertion, please use a new e-con connector.
- When connecting to PSE200/PSE300 controllers, please use the connector for sensor (ZS-28-C) or as detailed below.

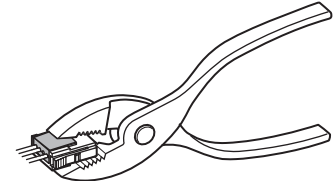

Maker	Model No.
(c)Sumitomo 3M	37104-3101-000FL
Tyco Electronics AMP	1473562-4
OMRON	XN2A-1430

- Please contact the connector manufacturer about *e-con* catalogue.

Connector Connecting/Disconnecting

- When connecting the connector, insert it straight onto the pins holding the lever and connector body, and lock the connector by pushing the lever claw into the square groove in the housing until connector clicks.
- When disconnecting the connector, press the connector lever to disengage the lever claw from the square groove. Then pull the connector straight out.

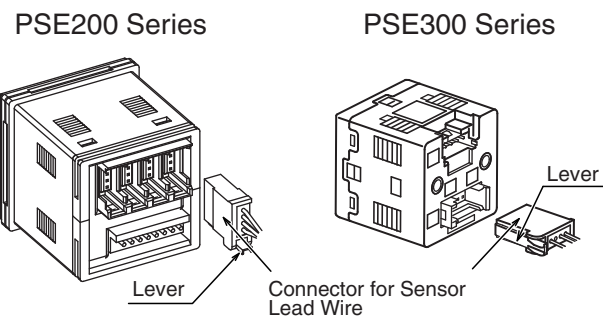

Contact

AUSTRIA	(43) 2262 62280	NETHERLANDS	(31) 20 531 8888
BELGIUM	(32) 3 355 1464	NORWAY	(47) 67 12 90 20
CZECH REP.	(420) 541 424 611	POLAND	(48) 22 211 9600
DENMARK	(45) 7025 2900	PORTUGAL	(351) 21 471 1880
FINLAND	(358) 207 513513	SLOVAKIA	(421) 2 444 56725
FRANCE	(33) 1 6476 1000	SLOVENIA	(386) 73 885 412
GERMANY	(49) 6103 4020	SPAIN	(34) 945 184 100
GREECE	(30) 210 271 7265	SWEDEN	(46) 8 603 1200
HUNGARY	(36) 23 511 390	SWITZERLAND	(41) 52 396 3131
IRELAND	(353) 1 403 9000	UNITED KINGDOM	(44) 1908 563888
ITALY	(39) 02 92711		

SMC Corporation

URL <http://www.smcworld.com> (Global) <http://www.smceu.com> (Europe)
 Specifications are subject to change without prior notice from the manufacturer.
 © SMC Corporation All Rights Reserved.